

'INTERRA

ITR3XX-XXXX

Product Manual



Information contained in this publication regarding device applications and the like is provided only for your convenience and may be superseded versions by updates. It is your responsibility to ensure that your application meets with your specifications.

INTERRA MAKES NO REPRESENTATIONS OR WARRANTIES OF ANY KIND WHETHER EXPRESS OR IMPLIED, WRITTEN OR ORAL, STATUTORY OR NONSTATUTORY, RELATED TO THE INFORMATION INCLUDING BUT NOT LIMITED TO ITS CONDITION, QUALITY, PERFORMANCE, MERCHANTABILITY OR FITNESS FOR PURPOSE.

Interra disclaims all liability arising from this information and its use. Use of Interra devices in life support and / or safety applications is entirely at the buyer's risk, and the buyer agrees to defend, indemnify and hold harmless Interra from any and all damages, claims, suits, or expenses resulting from such use. No licenses are conveyed, implicitly or otherwise under any Interra intellectual rights.

Trademarks

The Interra name and logo and the Interra ITR3XX–XXXX automation switch are registered trademarks of Interra Technology in Turkey and other countries.

All other trademarks mentioned herein are property of the Interra Technology.

© 2019, Interra, Printed in Turkey, All Rights Reserved.



Printed on recycled paper.

TS EN ISO 9001:2008

TO OUR CUSTOMERS

One of our most important aims is to provide you with the best documentation possible to use successfully your Interra products. Focusing of this, we will keep on improving our documentation to better suit your needs. Our publications will be updated as new volumes as soon as changes are introduced.

If you have any questions or comments regarding this publication, do not hesitate to contact us:

E-mail: info@interra.com.tr

Tel: +90 (216) 326 26 40 Fax: +90 (216) 324 25 03

Most Current Product Manual

To obtain the most up-to-date version of this product manual, please visit our Web site at:

<http://www.interra.com.tr>

You can determine the version of an Interra document examining its literature number found on the bottom right corner of any page.

The first two letters of the literature are the type of document. The numbers that follow are the creation date of the document and the last letter is the version (e.g., PM181017001A is the version A of a product manual created on the date 17/10/18).

DRRAFT

TABLE OF CONTENTS

1. CONTENT OF THE DOCUMENT	7
2. PRODUCT DESCRIPTION	8
2.1. TECHNICAL INFORMATION	9
2.2. MODELS AND VARIATIONS	10
2.3 DIMENSIONS	11
2.4. FUNCTIONAL DESCRIPTIONS	12
2.5. CONNECTION TO THE KNX BUS AND PROGRAMMING	13
3. MOUNTING	14
4. ISWITCH INTERNAL COMPONENTS	16
5. ETS PARAMETERS AND OBJECTS	18
5.1. GENERAL PAGE	18
5.1.1. Module Alive Beacon	19
5.1.2. LEDs Intensity	19
5.1.2. Alarm Flashing LEDs Function	19
5.1.3. Device Control Locking	19
5.1.4. Navigation LED	19
5.1.4. Parameters List	20
5.1.5. Object List	22
5.2. PUSH BUTTONS PAGE	22
5.2.1. Switching	22
5.2.1.1. Parameters List	23
5.2.1.2. Objects List	25
5.2.2. Toggle	26
5.2.2.1. Parameters List	26
5.2.2.2. Objects List	29
5.2.3. Dimming	29
5.2.3.1. Parameters List	30
5.2.3.2. Objects List	33
5.2.4. Shutter / Blinds	34
5.2.4.1. Parameters List	35
5.2.4.2. Objects List	37
5.2.5. Value	38
5.2.5.1. Parameters List	39
5.2.5.2. Objects List	42

5.2.6. 2 – Channel Mode	43
5.2.6.1. Parameters List	43
5.2.6.2. Objects List.....	47
5.2.7. Scene	48
5.2.7.1. Parameters List	49
5.2.7.2. Objects List.....	51
5.2.8. Thermostat Extension Control	51
5.2.8.1. Parameters List	52
5.2.8.2. Objects List.....	54
5.2.9. Step Switching	55
5.2.9.1. Parameters List	56
5.2.9.2. Objects List.....	58
5.3. TEMPERATURE SENSOR PAGE.....	60
5.3.1. Parameters List	60
5.3.2. Objects List.....	62
5.4. ROOM CONTROLLER PAGE	63
5.4.1. Control Types Theoretical Explanations.....	63
5.4.1.1. 2 – Points Control	63
5.4.1.2. Pwm Control.....	64
5.4.1.3. Continuous (PI) Control.....	65
5.4.2. General.....	66
5.4.2.1. Parameters List	67
5.4.2.2. Objects List.....	68
5.4.3. Heating	69
5.4.3.1. Heating 2 – Points Control.....	69
5.4.3.2. Parameters List	69
5.4.3.3. Objects List.....	70
5.4.3.4. Heating Pwm Control.....	70
5.4.3.5. Parameters List	71
5.4.3.6. Objects List.....	71
5.4.3.7. Heating Continuous Control	72
5.4.3.8. Parameters List	73
5.4.3.9. Objects List.....	73
5.4.3.10. Additional Heating System.....	74
5.4.3.11. Parameters List.....	74
5.4.3.12. Objects List	75

5.4.4. Cooling.....	75
5.4.4.1. Cooling 2 – Points Control.....	76
5.4.4.2. Parameters List	76
5.4.4.3. Objects List.....	77
5.4.4.4. Cooling Pwm Control.....	77
5.4.4.5. Parameters List	78
5.4.4.6. Objects List.....	78
5.4.4.7. Cooling Continuous Control	79
5.4.4.8. Parameters List	80
5.4.4.9. Objects List.....	80
5.4.4.10. Additional Cooling System.....	81
5.4.4.11. Parameters List.....	81
5.4.4.12. Objects List	82
5.4.5. Heating & Cooling	82
5.4.5.1. Parameters List	83
5.4.5.2. Objects List.....	84
5.4.6. Set Points	86
5.4.6.1. Parameters List	87
5.4.6.2. Objects List.....	88
5.4.7. Fan	89
5.4.7.1. Fan Indicator.....	89
5.4.7.2. Parameters List	90
5.4.7.3. Objects List.....	90
5.4.7.4. Fan Controller.....	92
5.4.7.5. Parameters List	92
5.4.7.6. Objects List.....	94
5.5. LCD PAGE.....	96
5.5.1. General.....	96
5.5.1.1. Parameters List	97
5.5.1.2. Objects List.....	99
5.5.2. Buttons.....	100
5.5.2.1. Parameters List	100
5.5.2.2. Objects List.....	103
5.6. HUMIDITY SENSOR.....	104
5.6.1. Parameters List	105
5.6.2. Objects List.....	106

1. CONTENT OF THE DOCUMENT

This document contains Interra's ITR3XX-XXXX coded iSwitch room controller device's electronic and all essential feature informations for programming this product. In each subtitle is explained about the characteristics of the device. Modifications of the product and special change requests are only allowed in coordination with product management.

DRAFT

2. PRODUCT DESCRIPTION

Interra iSwitch ITR3XX–XXXX, is a wall – mounting room controller for on / off switching loads, dimming of lighting devices, control of motor drives or other programmable switching and control functions. At the same time, iSwitch can be used as a secondary product that can act as a room probe or thermostat, at a section of the building or a room, an electronic digital temperature controller, heating, cooling and air conditioning control and regulation. iSwitch room temperature controller is developed according to the KNX standard for using in houses and buildings control systems. iSwitch room temperature controller thanks to integrated sensors is can be used for heating, cooling and air condition and regulation, also can measures room temperature and relative humidity values directly. iSwitch can receive temperature, relative humidity and CO2 concentration values from other bus devices via KNX bus system. In iSwitch models with LCD display, related to room controller function various informations can be displayed visually.

iSwitch is equipped with a user interface to display room air conditions and modify desired setpoint. Depending on the air conditioning infrastructure, end user can determine up to 5 different fan speed values manually or automatically, working at integrated system. iSwitch product range include 9 different models, there are 3 models with LCD display, 6 models without LCD. In models with LCD display, LCD is located vertically at the center area of the product between the gangs. In models without LCD display (except 10 button model) the center area is designed as a blank cover like the other buttons which got same materials to provide decorative fit. In 10 button model without LCD, the center area buttons are designed with same materials like other button covers that provides decorative fit with 2 separate buttons. All iSwitch models can be programmed with only one database.

iSwitch product can be attached to ETS database file, and the model used in the project is selected on the same file hence it is aimed to program the devices in a flexible structure, and a simple system that is not complex are presented to the implementers.

iSwitch is equipped with an integrated KNX bus communication module and is designed for wall installation on flush mounting box. Several colour variations and materials of plates are available (nonflammable plastic, aluminium, stainless steel, glass and each materials has colour options) which can be combined in order to obtain different combinations. All RAL codes, except the standard ones, can be produced by users request.

2.1. TECHNICAL INFORMATION

Device	ITR3XX–XXXX
Power Supply	EIB Power Supply
Power Consumption	ITR301-0XXX: 10mA ITR308-1XXX: 18mA
Push Buttons	Depends on model (1 to 10 button) 1 x KNX Programming Button
LED Indicators	RGB LEDs for each button 1x Blue Navigation LED 1x Red Programming LED
Sensors	Temperature Sensor ($\pm 0.2^{\circ}\text{C}$ sens.) Humidity Sensor ($\pm 2\%$ RH C sens.)
Interfaces	VA-Type low power LCD
Mode of Commissioning	S-Mode
Type of Protection	IP 20
Temperature Range	Operation ($-10^{\circ}\text{C} \dots 70^{\circ}\text{C}$) Storage ($-25^{\circ}\text{C} \dots 100^{\circ}\text{C}$)
Maximum Air Humidity	<90 RH
Flammability	Non – flammable Product
Colour	Buttons: Depends on models Back Cover: Matte Black
Dimensions	90x90x12mm (WxHxD)
Certification	KNX Certified
Configuration	Via ETS Software

2.2. MODELS AND VARIATIONS

I T R 3 X X - X X X X

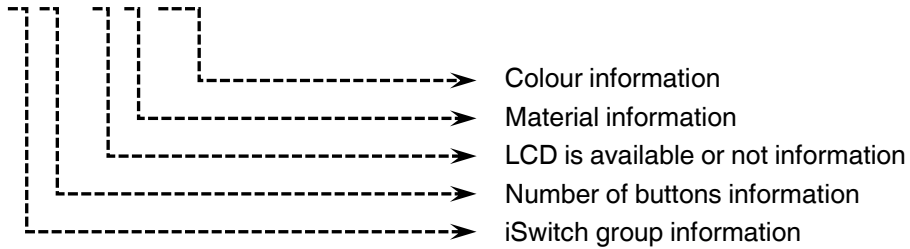

Models with LCD

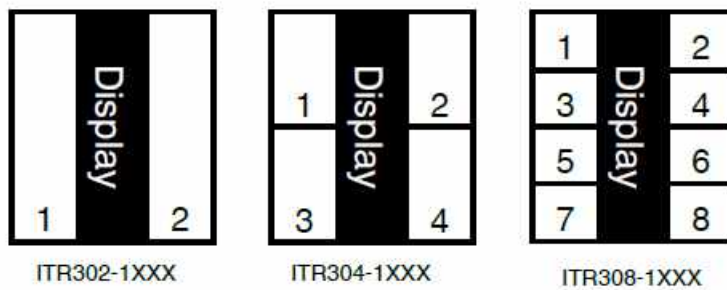

Fig 1 : View of 3 different models with LCD

Models without LCD

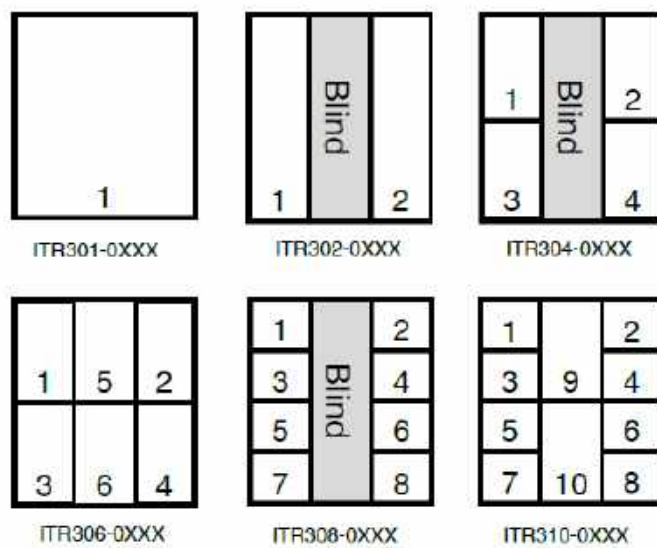

Fig 2 : View of 6 different models without LCD

Materials and Colour Options

Material and color options can be exclusively designed for special projects.

Non – Flammable Plastic	Aluminium	Stainless Steel	Glass
01 – Black	00 – Natural	00 – Natural	01 – Black
02 – Glossy White	01 – Black		02 – White
03 – Matt White	02 – Champagne		
04 – Anthracite Matt			
05 – Metallica Gray			

2.3 DIMENSIONS

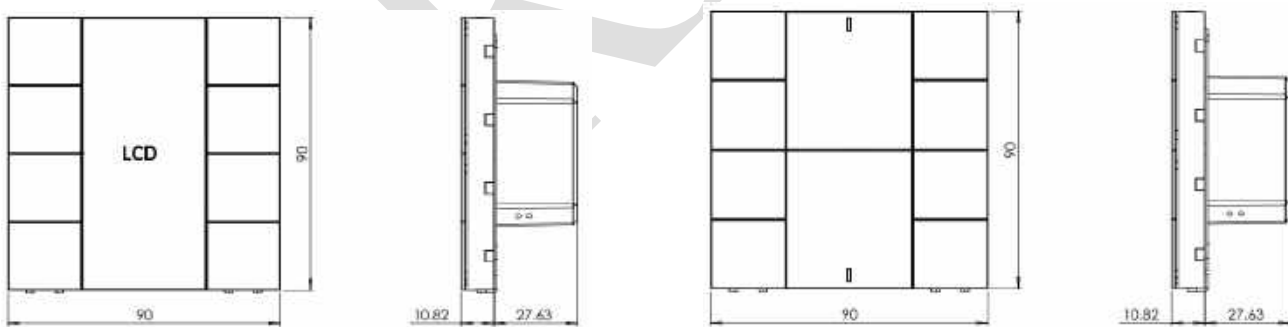

Fig 3 : Dimensions of the iSwitch

All of the iSwitch models, with or without LCD, have got the same dimensions.

2.4. FUNCTIONAL DESCRIPTIONS

The prominent features of the iSwitch ITR3XX–XXXX's are followings :

- All 9 models can be programmable with only one database.
- Switching, toggle, dimming, shutter / blinds controls, predetermined scenes by users, value functions that can send preset values , 2 channels control functions, thermostat air conditioning functions, step switching mode features are available.
- Scenes from 1 to 64 can be specified and these scenes can be implemented by request.
- Thermostat air conditioning functions can be used and switch between air conditioning modes.
- Room temperature regulation can be done with 2 – Points(Hysteresis), PWM or Continuous PI control options.
- Operating modes : comfort, standby, economy and building protection.
- Automatic switching between operating modes via KNX bus line.
- Temperature measuring through integrated sensors with possibility of sending the value on the bus.
- Relative humidity measuring through integrated sensors with possibility of sending value on the bus.
- Humidification and dehumidification control.
- LED configuration is available.
- Locking is available for all features.
- Ventilation control with continuous or 5 – speed regulation
- Internal or external conditions can be sent to the bus line within the operating modes.
- External – internal temperature, (measured, setpoint, outdoor values as °C and °F), operating mode, settings, CO2 concentration, fan control, humidity, on/off features are displayed on LCDs.

2.5. CONNECTION TO THE KNX BUS AND PROGRAMMING

The connection of the KNX bus line is made with the terminal block (black / red socket group) included in delivery and inserted into the slot of housing.

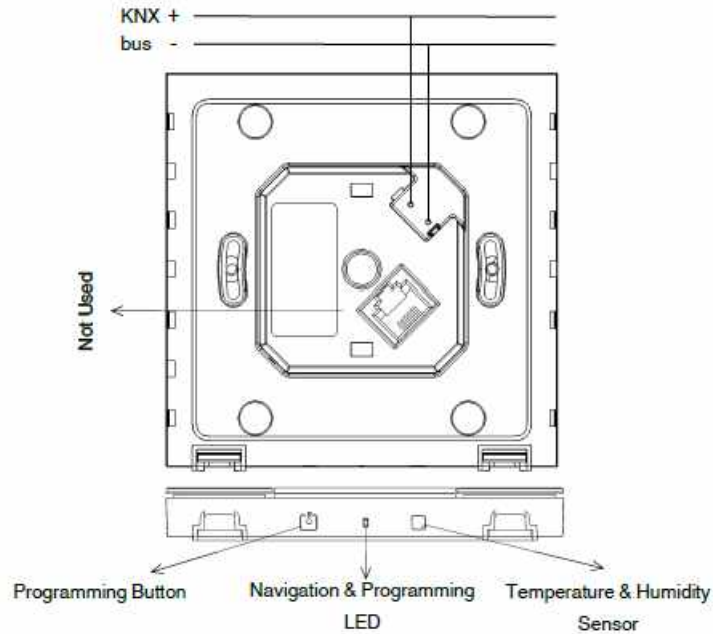

Fig 4 : Connection to KNX and Programming Button

After pressing the buttons on the top left and bottom left corner of the device simultaneously, the programming LED is activated by pressing the button in the bottom right corner and LED's red light is on. Also this can be done by pressing the programming button as another method. In the circumstances, the device is ready for programming.

3. MOUNTING

The iSwitch's mounting steps are described below. The procedures are described in 2 main sections : Mounting of BCU and Mounting of Application board.

Mounting of BCU

The device is suitable for use in dry interior rooms and can only be mounted on a standard sized round or square wall flush mounting box. The BCU should be mounted after the wall painting process is finished. Otherwise, the product's cosmetics may be damaged. The mounting steps are shown below.

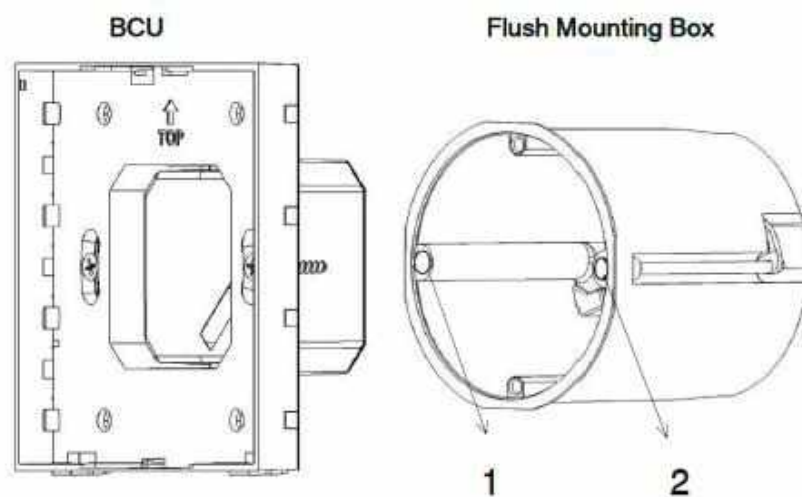

Fig 5 : Mounting the BCU to Flush Mounting Box

- 1-) First, the wall flush mounting box installation whether is done properly should be checked.
- 2-) Second, iSwitch's BCU part is placed to wall flush mounting box considering the "TOP" writing which is located on the upper side of the BCU must be demonstrated up direction.
- 3-) Third, the screws are guided through number "1" and number "2" holes that are shown above.
- 4-) Finally, The BCU should be aligned by scales that is positioned decently, then tighten the guided screws.

Mounting of Application Board

After a successful BCU mounting, iSwitch's Application Board must be mounted on the BCU part. The mounting steps are described below.

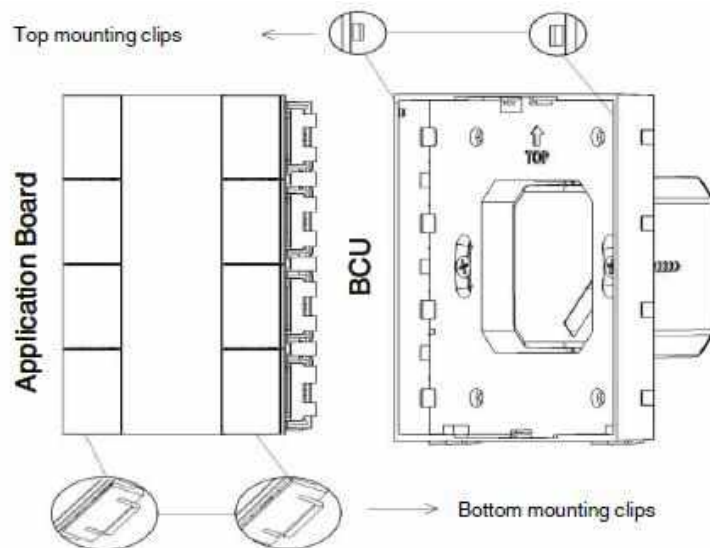

Fig 6 : Mounting the Application Board to BCU

- 1-) First, communication connector on the Application board that will be attached to the BCU part.
- 2-) Second, when connection is succeeded, Application board is ready to be connected and it must be slightly approached to BCU.
- 3-) Third, Application Board should be held at an angle of approximately 45 degrees, after that its top side notches must be inserted to BCU top hidden mounting clips.
- 4-) Finally, lower side notches should be gently seated in the slot of the BCU side.

Demounting of Application Board

- 1-) First, lower side notches pushed backwards from the underside of the device.
- 2-) Second, Application Board should be held at an angle of approximately 45° and the top side notches are pulled from the top of the device.
- 3-) Third, Application Board's communication connector should be removed from the BCU.
- 4-) Finally, application board is demounted from the BCU.

4. ISWITCH INTERNAL COMPONENTS

Models with LCD

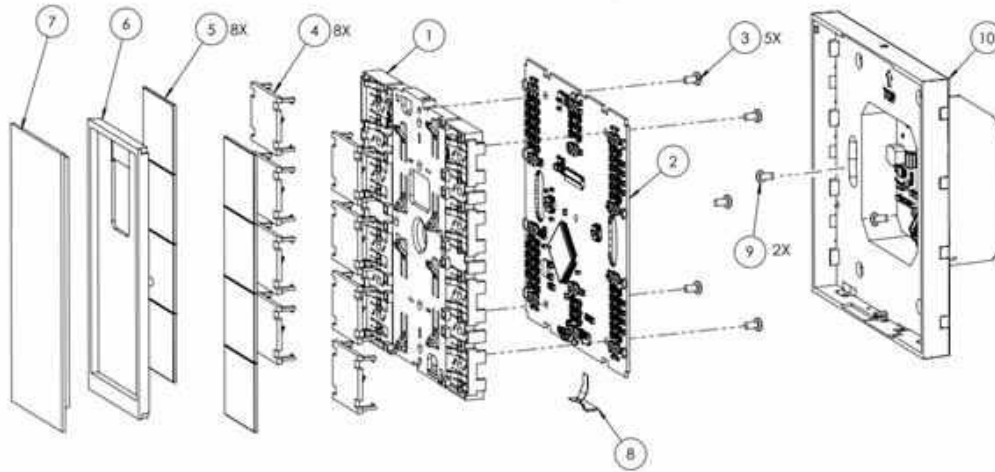

Fig 7 : Internal Componenets of Models with LCD

Item No	Part Name	Description	Qty.
1	Front Cover	ABS – PC Front cover	1
2	Main Board	Hardware depends on models	1
3	Screw	M 2x4 (mm)	5
4	Button Mechanism	ABS – PC button mechanism	8
5	Button Cover	Depends on the material selection	8
6	LCD Cover	ABS-PC plastic LCD cover	1
7	LCD Display	VA – Type LCD	1
8	Sensor & LED	Temperature & humidity sensor, navigation & programming LED	1
9	Screw	M 2x4 (mm)	2
10	BCU	Common for all models	1

Models without LCD

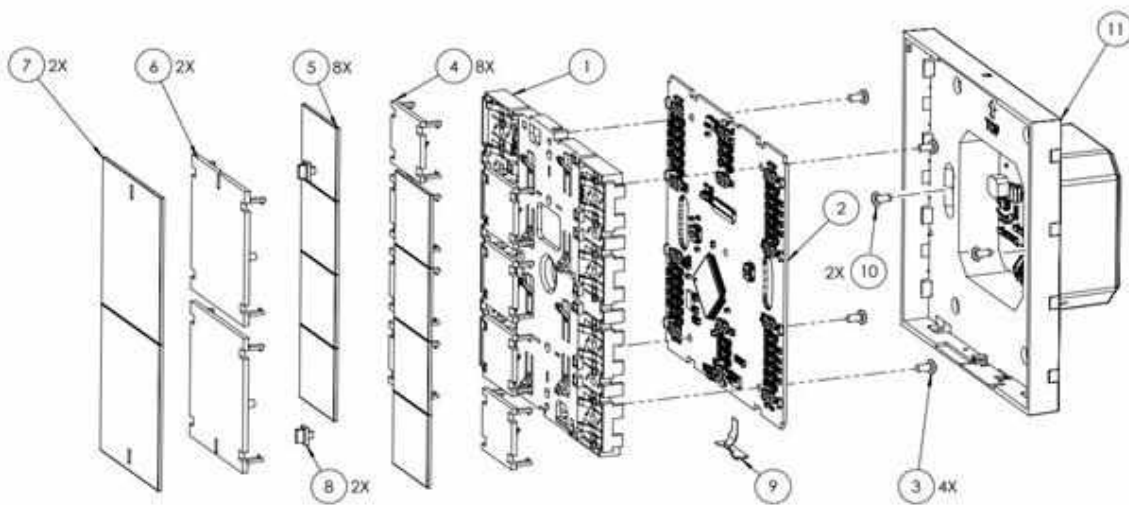

Fig 8 : Internal Component of Models without LCD

Item No	Part Name	Description	Qty.
1	Front Cover	ABS – PC Front cover	1
2	Main Board	Hardware depends on models	1
3	Screw	M 2x4 (mm)	5
4	Button Mechanism	ABS – PC button mechanism	8
5	Button Cover	Depends on the material selection	8
6	Button Mechanism	ABS-PC button mechanism	1
7	Button Cover	Depends on the material selection	1
8	Front Diffuser	LED diffuser	1
9	Sensor & LED	Temperature & humidity sensor, navigation & programming LED	2
10	Screw	M 2x4 (mm)	1
11	BCU	Common for all models	1

5. ETS PARAMETERS AND OBJECTS

5.1. GENERAL PAGE

When the iSwitch ITR3XX-XXXX is attached to the project from the ETS program, a configuration setting must be made primarily before loading, depending on the model to be programmed. When entering the “GENERAL” in the parameter page, the configuration screen will appeared shown above. As previously mentioned, all models can be configured via an ETS file thus the programmers can work flexibly.

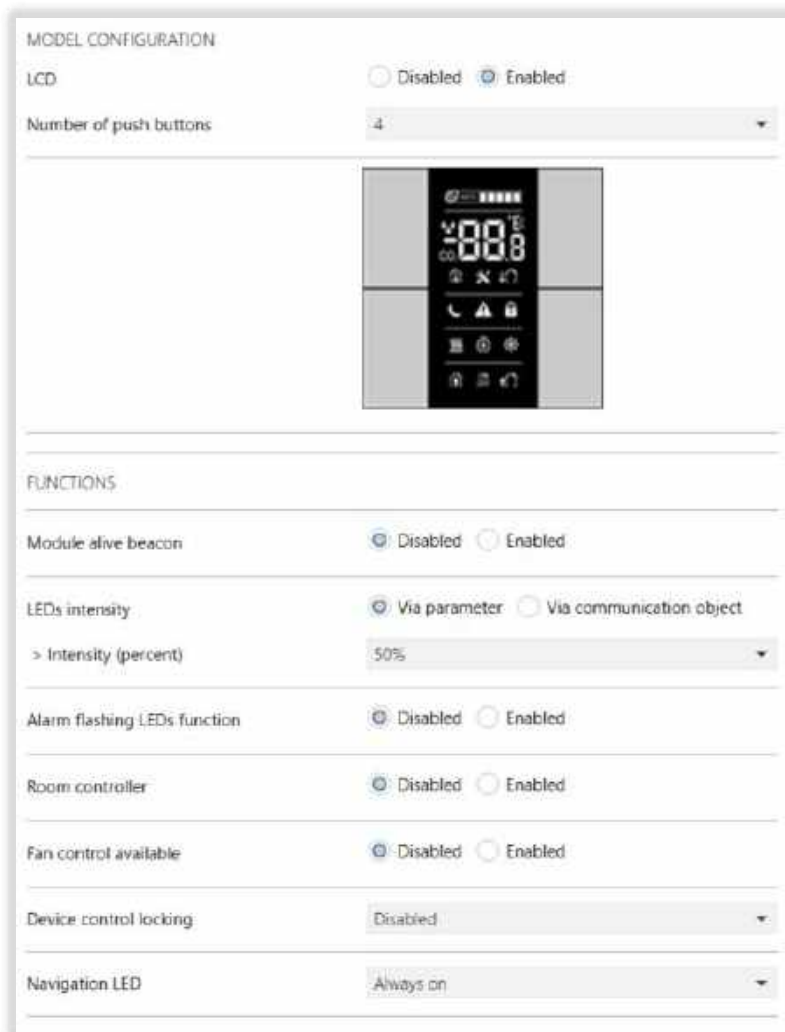

Fig 9 : General Parameter Configuration Page

According to the model of the device, the programmer can configure the LCD exists or not and the number of push buttons via corresponding tabs. To ensure that the models are selected correct and also to be able to program correctly, the iSwitch model appears at the screen as shown above.

For some reason, the user can be able to program the device by choosing the wrong model without realizing it. A feature is available for the programmer to recognize its mistakes : When the programmer performs this operation, all of the push buttons' LEDs on the iSwitch's will start flashing. If the iSwitch model is a model with LCD, there will be no display on the LCD. Thus, the programmer can easily recognize the fault it did and reconfigure the device with correct one. Moreover, It is possible to select the action to be performed when the power cut occurs or the KNX bus line power is restored in which the device is connected to related KNX bus line.

5.1.1. Module Alive Beacon

This function has an important role to detect the device is working or not. With enabling the "Module Alive Beacon" parameter, it is possible to know if the device is working properly. A value of true is sent with a preset time via the "Module Alive Beacon" object. If this telegram is received periodically, it shows that the device is working properly. Since the period time is in seconds, it is better to keep the period time higher in order not to increase the bus line traffic.

5.1.2. LEDs Intensity

LEDs can be configured via parameter or via a 1byte communication object. If it is selected as "via parameter", it is configured multiplies of 10 as percent.

5.1.2. Alarm Flashing LEDs Function

This function is used for giving visual message to the user understanding there is an alarm situation according to the configuration made before. All of the button LEDs will be flashing when this event is triggered.

5.1.3. Device Control Locking

This device can be locked when it is wanted. With "Device Control Locking" object, when device locking is enabled, device is locked and no longer sends telegram to KNX bus line. Device remembers the previous condition and works in this manner until the locking is disabled.



Device locking function will be enabled after the KNX bus line power cuts are restored.

5.1.4. Navigation LED

Navigation LED is used to show a pleasant display generally in dark ambient. It can be configured via a 1 bit communication object or "always on" and "always off" parameter options.

5.1.4. Parameters List

PARAMETERS	DESCRIPTION	VALUES
LCD	This parameter, determines the model is with or without LCD.	Enabled Disabled
Number of push buttons	This parameter, determines the number of push buttons depends on the model with or without LCD.	1 2 4 6 8 10
Module alive beacon	This parameter, allows sending the value “true” periodically while the module is running.	Disabled Enabled
Interval (sec)* ¹	This parameter, determines the sending period of “Module alive beacon” in seconds.	3600 (1...65535)
LEDs intensity	<p>This parameter, is used to configure LEDs' intensity.</p> <p>Via parameter : LEDs' luminance intensity is determined from the parameter settings. Once the “%” configuration is set, the configured parameter settings will be used, unless it is programmed again via ETS.</p> <p>Via communication object : LEDs' luminance intensity is determined by a related group address on the KNX bus line. According to sent value, with a 1 byte data(0..255) the luminance configuration can be done.</p>	Via parameter Via communication object
Intensity(percent) * ²	This parameter, allows you to set the intensity of the LEDs' in percent over the ETS parameter.	50% (10%, 20%, 30%, 40%, 50%, 60%, 70%, 80%, 90%, 100%)
Alarm flashing LEDs function	This parameter, is used to receive warnings via the LEDs when an alarm event occurs. In the event of an alarm, all LEDs start to flash.	Disabled Enabled
Room controller** ³	This parameter is used to control the thermostat features. The settings for room controller is described in details at the related subtitles.	Disabled Enabled

Fan control available	Whether to perform fan controls is set with this parameter.	Disabled Enabled
Fan control used for room controller^{*4}	This parameter determines the fan controls that are used inside or outside of the thermostat function. If the it is selected to use outside of the thermostat function, just the fan states will be displayed on the device.	Disabled Enabled
Device control locking	This parameter determines whether the device lock is enabled with an additional locking object. Disabled : With this option, device lock is disabled permanently. Lock on value 0 : When a logic 0 value is send to device control locking object, the device will be locked. Lock on value 1 : When a logic 1 value is send to device control locking object, the device will be locked.	Disabled Lock on value 0 Lock on value 1
Navigation LED	There is a navigation LED under the device. This parameter is used to control the determined LED. Always off : Navigation LED is permanently off. Always on : Navigation LED is permanently on. Via communication object : When this paramater is selected, the navigation LED's control will be done with "LEDs Intensity" object that will be opened in the device object list.	Always off Always on Via communication object

^{*1}This parameter is only visible, when the parameter "Module alive beacon" at the GENERAL parameter page is set to "Enabled".

^{*2}This parameter is only visible, when the function "LEDs intensity" at the GENERAL parameter page is set to "Via parameter".

^{*3}This parameter page is only visible, when the function "Room controller" at the GENERAL parameter page is set to "Enabled".

^{*4}This parameter is only visible, when the parameter "Fan control available" is set to "Enabled".

5.1.5. Object List

Object Name	Function	Type	Flags
Alive Beacon	1 : Enabled / 0 : Disabled	1 bit	CRT
This object is only visible when “Module Alive Beacon” function is enabled. Device sends “true” values via the connected group address while it is working.			
Leds intensity	10%, 20%, 30%, 40%, 50%, 60%, 70%, 80%, 90%, 100%	1 byte	CWT
The intensity of LEDs’ is set via this object.			
LEDs Flashing Function	1 : Enabled / 0 : Disabled	1 bit	CRWTU
This object controls the flashing action of the LEDs.			
Device Control Locking	0 : Enabled / 1 : Disabled 1 : Enabled / 0 : Disabled	1 bit	CWT
Device control is blocked by this object.			
Navigation LED	1 : Enabled / 0 : Disabled 0 : Enabled / 1 : Disabled	1 bit	CWT
The navigation LED is controlled by this object.			

5.2. PUSH BUTTONS PAGE

5.2.1. Switching

This function is used to perform the switching operation. Depending on the settings configured in the switching process, when the button is pressed or released, the ON or OFF values are generated. After each operation a telegram is sent to KNX bus line. Telegram is generated based on the configured settings.

If you want to configure the push button with “switching” function choose it from the parameter page and then a new object will be appear under the device object list at the left side. This object’s name is “switching”. General configurations are made via this object. When the “switching” function is enabled, it is added to object list of the device. After assigning the group address to this object, attention should be paid to the type of data it uses. It is a good technique to use default data types.

Fig 10 : Switching Function Configuration

5.2.1.1. Parameters List

PARAMETERS	DESCRIPTION	VALUES
On press / On release	<p>This parameter determines how the push buttons will work with switching control function.</p> <p>On / - : When pressed to push button ON value will be sent, when released nothing will be sent.</p> <p>Off / - : When pressed to push button OFF value will be sent, when released nothing will be sent.</p> <p>- / On : When pressed to push button nothing will be sent, when released ON value will be sent.</p> <p>- / Off : When pressed to push button nothing will be sent, when released OFF value will be sent.</p>	On / - Off / - - / On - / Off
Sending delay (sec)	<p>When an event occurs, this parameter allows to configure telegram sending time to bus line. Values are entered in seconds. Entering the "0" value means which the telegram is sent to bus line without delay.</p>	0 (0...255)
Sending periodically	<p>This parameter is used to periodically send the commands to bus line.</p>	Disabled Enabled
Period of sending (sec)*¹	<p>This parameter determines sending periods of the commands to bus line.</p>	0 (0...255)

Push button locking	<p>This parameter determines whether the push button lock is enabled with an additional locking object. When this function used, the locked push button does not send any data to the bus line.</p> <p>Disabled : With this option, device lock is disabled permanently.</p> <p>Lock on value 0 : When a logic 0 value is send to push button locking object, the push button will be locked.</p> <p>Lock on value 1 : When a logic 1 value is send to push button locking object, the push button will be locked.</p>	Disabled Lock on value 0 Lock on value 1
Locking after voltage failure* 2	<p>Previous value : Push button takes the value at before the voltage failure status.</p> <p>Locking enabled : Even if the push button is not locked before voltage failure, the button will be locked after voltage failure.</p> <p>Locking disabled : Even if the push button is locked before voltage failure, the button will not be locked after voltage failure.</p>	Previous value Locking enabled Locking disabled
Behaviour at beginning of locking* 2	<p>This parameter allows to change status of the push button or, at the beginning of lock status transition, it saves the assigned “on” or “off” values.</p>	No reaction – Last state On Off
Behaviour at end of locking* 2	<p>This parameter allows to change status of the push button or, at the end of lock status transition, it saves the assigned “on” or “off” values.</p>	No reaction – Last state On Off
LED configuration	<p>This parameter allows to control LED status of the button.</p> <p>Always on : The button LED is always on whether button is pressed .</p> <p>Always off : The button LED is always off whether button is pressed or not.</p> <p>On press / On release : When the push button is pressed or released, the push button LED is on or off.</p> <p>Led status object : LED’s control is done via led status object.</p>	Always on Always off On press / On release LED status object

LED color on press*³	This parameter allows to control button LED when push button is pressed.	White (Red, Green, Blue, White, Off)
LED color on release*³	This parameter allows to control button LED when push button is released.	Off (Red, Green, Blue, White, Off)
Release delay (sec) *³	This parameter determines a release delay for controlling the button LED when push button is released.	0 (0...255)
LED color for on*⁴	LED color is selected by this parameter when the status is "ON".	White (Red, Green, Blue, White)
LED color for off⁴	LED color is selected by this parameter when the status is "OFF".	Off (Red, Green, Blue, White, Off)
Polarity*⁴	LED's polarity is selected by this parameter.	Normal Inverted

*¹This parameter is only visible, when the parameter "Sending periodically" is set to "Enabled".

*²This parameter is only visible, when the parameter "Push button locking" is set to "Lock on value 0" or "Lock on value 1".

*³This parameter is only visible, when the parameter "LED configuration" is set to "On press / On release".

*⁴This parameter is only visible, when the parameter "LED configuration" is set to "LED status object".

5.2.1.2. Objects List

The following objects can be used via switching function.

Object Name	Function	Type	Flags
Button X – Switching	1 – On / 0 – Off	1 bit	CWT

Switching telegram will be sent via this object connected to related group address.

Button X – Locking	0 – Disable / 1 – Enable	1 bit	CWT
--------------------	--------------------------	-------	-----

This object appears only when the locking function is enabled. Via the related group address, it is possible to lock the push button by configuration is done before.

Button X – LED Status	1 – ON / 0 – OFF	1 bit	CWT
-----------------------	------------------	-------	-----

This object appears only when the LED configuration parameter is selected as LED status object. It is possible to control the push button LED by configuration is done before.

5.2.2. Toggle

Fig 11 : Toggle Function Configuration

While the Toggle function is selected, every each time the button is pressed, the value "1" or "0" value is sent to the bus line via the object of the push button. If first time the button is pressed and the "1" value is sent, when the button pressed next time the value "0" will be sent. Every press to the push button the output value is always changed to "1" or "0" and they will be sent to bus line. The current values of the object can be updated by the devices at the same KNX bus line. There is a push button status object to prevent sending wrong commands to bus line. 4 different objects can be programmed with toggle function. These objects are shown below.

5.2.2.1. Parameters List

PARAMETERS	DESCRIPTIONS	VALUES
On press / On release	<p>This parameter determines how the push buttons will work with toggle control function.</p> <p>Toggle / - : When pressed to push button, inverted values of the current ones will be sent.</p> <p>- / Toggle : When push button is released, inverted values of the current ones will be sent.</p> <p>Toggle / Toggle : When pressed to push button, inverted values of the current ones will be sent. After that, when push button is released, inverted values of the updated ones will be sent.</p>	<p>Toggle / -</p> <p>- / Toggle</p> <p>Toggle / Toggle</p>

Sending delay (sec)	When an event occurs, this parameter allows to configure telegram sending time to bus line. Values are entered in seconds. Entering the “0” value means which the telegram is sent to bus line without delay..	0 (0...255)
Push button locking	This parameter determines whether the push button lock is enabled with an additional locking object. When this function used, the locked push button does not send any data to the bus line. Disabled : With this option, device lock is disabled permanently. Lock on value 0 : When a logic 0 value is send to push button locking object, the push button will be locked. Lock on value 1 : When a logic 1 value is send to push button locking object, the push button will be locked.	Disabled Lock on value 0 Lock on value 1
Locking after voltage failure*¹	Previous value : Push button takes the value at before the voltage failure status. Locking enabled : Even if the push button is not locked before voltage failure, the button will be locked after voltage failure. Locking disabled : Even if the push button is locked before voltage failure, the button will not be locked after voltage failure.	Previous value Locking enabled Locking disabled
Behaviour at beginning of locking*¹	This parameter allows to change status of the push button or, at the beginning of lock status transition, it saves the assigned “on” or “off” values.	No reaction – Last state On Off Toggle
Behaviour at end of locking*¹	This parameter allows to change status of the push button or, at the end of lock status transition, it saves the assigned “on” or “off” values.	No reaction – Last state On Off Toggle

LED configuration	<p>This parameter allows to control LED status of the button.</p> <p>Always on : The button LED is always on whether button is pressed .</p> <p>Always off : The button LED is always off whether button is pressed or not.</p> <p>On / Off object : When pressed to push button and ON value is generated, the color of the LED is set to ON status setting value. Same applies are valid for OFF status.</p> <p>Feedback object : The push button's configured LED color for ON and OFF status, is turned on via the toggle function feedback object.</p> <p>On press / On release : When the push button is pressed or released, the configured color of push button LED is turned on.</p> <p>Led status object : LED's control is done via led status object.</p>	<p>Always on</p> <p>Always off</p> <p>On / Off object</p> <p>Feedback object</p> <p>On press / On release</p> <p>LED status object</p>
LED color on press*²	<p>This parameter allows to control button LED when push button is pressed.</p>	<p>White (Red, Green, Blue, White, Off)</p>
LED color on release*²	<p>This parameter allows to control button LED when push button is released.</p>	<p>Off (Red, Green , Blue, White, Off)</p>
Release delay (sec) *²	<p>This parameter determines a release delay for controlling the button LED when push button is released.</p>	<p>0 (0...255)</p>
LED color for on*³	<p>LED color is selected by this parameter when the status is "ON".</p>	<p>White (Red, Green, Blue, White)</p>
LED color for off*³	<p>LED color is selected by this parameter when the status is "OFF".</p>	<p>Off (Red, Green , Blue, White, Off)</p>
Polarity*⁴	<p>LED's polarity is selected by this parameter.</p>	<p>Normal</p> <p>Inverted</p>

¹This parameter is only visible, when the parameter "Push button locking" is set to "Lock on value 0" or "Lock on value 1".

²This parameter is only visible, when the parameter "LED configuration" is set to "On press / On release".

³This parameter is only visible, when the parameter "LED configuration" is set to "On / Off object", "Feedback object" or "LED status object".

*4This parameter is only visible, when the parameter “LED configuration” is set to “Feedback object” or “LED status object”.

5.2.2.2. Objects List

The following objects can be used via toggle function.

Object Name	Function	Type	Flags
Button X – Switching	On / Off	1 bit	CRT
Toggle telegram will be sent via this object connected to related group address.			
Button X – Feedback On / Off	Status	1 bit	CRWU
Output status is shown via this object connected to related group address.			
Button X – Locking	0 – Disable / 1 – Enable	1 bit	CRT
This object appears only when the locking function is enabled. Via the related group address, it is possible to lock the push button by configuration is done before.			
Button X – LED Status	1 – On / 0 – Off	1 bit	CRT

This object appears only when the LED configuration parameter is selected as LED status object. It is possible to control the push button LED by configuration is done before.

5.2.3. Dimming



Fig 12 : Dimming Function Configuration

This feature enables increasing or decreasing of lighting circuit's lighting level. There are 2 different objects for each functions and they are controlled by button pressing times. Pressing short time to the push button, on or off value(1 bit) is sent via "On / Off" object. If the push button is pressed longer time, this action interpreted as a dimming function and value(4 bit) is sent via "dimming" object. The minimum time to detect the long press action is configured via parameter. When the button is released after a long press, the "stop" telegram is sent to bus line and dimming control is over. Dimming control can be done by 1 button toggle or 2 button up / down control modes.

Dimming control by 1 button ; At this option, 1 push button is used for dimming control. Short presses are always interpreted as recursive ON or OFF toggle (function described above) control events. When long press action occurs, each time pressed to button, "up" or "down" values(4 bit) are sent via dimming object to bus line. IF first time long press is sent as "up" command, next one's value is sent inverted as "down". There is a push button status object to prevent sending wrong commands to bus line and the current values of the object can be updated by the devices at the same KNX bus line. This object must be connected to actuator's status parameter via related group address. **Dimming control by 2 button ;** At this option, 2 push button is used for dimming control. Each command executes the parameters described as "up" and "down" via "direction" parameter. If a push button is configured as "up", each short press sends "ON" command to bus line. As long as the same button pressed, 4 bit value is sent to increase the lighting level via "dimming" object. If a push button is configured as "down", each short press sends "OFF" command to bus line.. As long as the same button pressed, 4 bit value is sent to decrease the lighting level via "dimming" object. 5 different objects can be programmed with dimming function.

5.2.3.1. Parameters List

PARAMETERS	DESCRIPTION	VALUES
Control mode	<p>This parameter is used for configure the dimming function as "1 button toggle" or "2 buttons up / down" control modes.</p> <p>1 Button toggle : When the push button is pressed short time, inverted value is sent to bus line instead of the current one via "On / Off" object. If the push button is pressed long time, "up" or "down" telegram is sent via "dimming" object. After a long press action, when the button is released, a "stop" telegram is sent to bus line.</p> <p>2 Buttons up / down : When the push button is pressed short time, "ON" value corresponds to "UP" direction parameter or "OFF" value corresponds to "DOWN" direction parameter. Its value is sent via "ON / OFF" object. : When the push button is pressed long time, a dimming telegram is sent via "dimming" object. After a long press action, when the button is released, a "stop" telegram is sent to bus line.</p>	<p>1 Button toggle</p> <p>2 Buttons up / down</p>

Direction¹	<p>This parameter determines the behaviour of the push button's when "2 buttons dimming" object is selected.</p> <p>Up : When the push button is pressed short time, "ON" value is sent via "On / Off" object. When the push button is pressed long time, "UP" value is sent via "Dimming" object.</p> <p>Down : When the push button is pressed short time, "OFF" value is sent via "On / Off" object. When the push button is pressed long time, "DOWN" value is sent via "Dimming" object.</p>	Up Down
Long press duration	<p>This parameter determines the minimum value to detect long press action.</p>	0.4 sec 0.5 sec 0.6 sec 0.7 sec 0.8 sec 0.9 sec 1.0 sec
Push button locking	<p>This parameter determines whether the push button lock is enabled with an additional locking object. When this function used, the locked push button does not send any data to the bus line.</p> <p>Disabled : With this option, device lock is disabled permanently.</p> <p>Lock on value 0 : When a logic 0 value is sent to push button locking object, the push button will be locked.</p> <p>Lock on value 1 : When a logic 1 value is sent to push button locking object, the push button will be locked.</p>	Disabled Lock on value 0 Lock on value 1
Locking after voltage failure*²	<p>Previous value : Push button takes the value at before the voltage failure status.</p> <p>Locking enabled : Even if the push button is not locked before voltage failure, the button will be locked after voltage failure.</p> <p>Locking disabled : Even if the push button is locked before voltage failure, the button will not be locked after voltage failure.</p>	Previous value Locking enabled Locking disabled

Behaviour at beginning of locking*²	This parameter allows to change status of the push button or, at the beginning of lock status transition, it saves the assigned “on” or “off” values.	No reaction – Last state On Off
Behaviour at end of locking*²	This parameter allows to change status of the push button or, at the end of lock status transition, it saves the assigned “on” or “off” values.	No reaction – Last state On Off
LED configuration	<p>This parameter allows to control LED status of the button.</p> <p>Always on : The button LED is always on whether button is pressed.</p> <p>Always off : The button LED is always off whether button is pressed or not.</p> <p>On press / On release : When the push button is pressed or released, the push button LED is on or off.</p> <p>Led status object : LED’s control is done via led status object.</p>	Always on Always off On press / On release LED status object
LED color on press*³	This parameter allows to control button LED when push button is pressed.	White (Red, Green, Blue, White, Off)
LED color on release*³	This parameter allows to control button LED when push button is released.	Off (Red, Green, Blue, White, Off)
Release delay (sec) *³	This parameter determines a release delay for controlling the button LED when push button is released.	0 (0...255)
LED color for on*⁴	LED color is selected by this parameter when the status is “ON”.	White (Red, Green, Blue, White)
LED color for off*⁴	LED color is selected by this parameter when the status is “OFF”.	Off (Red, Green, Blue, White, Off)
Polarity*⁴	LED’s polarity is selected by this parameter.	Normal Inverted

*¹This parameter is only visible, when the parameter “Control mode” is set to “2 Buttons up / down”.

*²This parameter is only visible, when the parameter “Push button locking” is set to “Lock on value 0” or “Lock on value 1”.

*³ This parameter is only visible, when the parameter “LED configuration” is set to “On press / On release”.

*⁴ This parameter is only visible, when the parameter “LED configuration” is set to “LED status object”.

5.2.3.2. Objects List

The following objects can be used via dimming function.

Object Name	Function	Type	Flags
Button X – Switching	On / Off	1 bit	CRT

Toggle telegram will be sent via this object connected to related group address.

Button X – Feedback On / Off	On / Off Status	1 bit	CRWU
---------------------------------	-----------------	-------	------

This object can only be seen when “1 button toggle” control mode is selected. Output status is shown via this object connected to related group address.

Button X – Dimming	Dimming control 1 – Step Up / 0 – Step Down	4 bit	CWT
--------------------	--	-------	-----

Toggle telegram will be sent via this object connected to related group address.

Button X – Locking	0 – Disable / 1 – Enable	1 bit	CWT
--------------------	--------------------------	-------	-----

This object appears only when the locking function is enabled. Via the related group address, it is possible to lock the push button by configuration is done before.

Button X – LED Status	1 – On / 0 – Off	1 bit	CWT
-----------------------	------------------	-------	-----

This object appears only when the LED configuration parameter is selected as LED status object. It is possible to control the push button LED by configuration is done before.

5.2.4. Shutter / Blinds

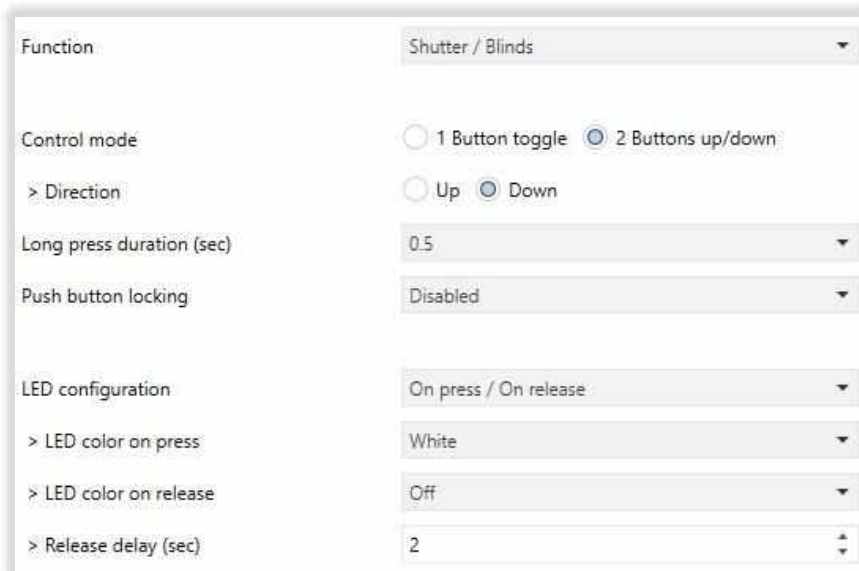

Fig 13 : Shutter/Blinds Function Configuration

A shutter / blinds circuit can be controlled up – down or on – off methods with “slat angle / stop” object by courtesy of this feature. Each function has 2 different “up / down” and “slat angle / stop” objects. At the control of shutter / blinds circuit, short press of the button sends “step movement” telegram and long press of the button sends “nonstop movement” telegram to bus line. A shutter / blinds circuit is controlled by “1 button toggle” or “2 buttons up / down” control modes.

Shutter / blinds circuit control with 1 button ; Push up, pull down and stop controls can be done with 1 push button. At every time of short press, the push button will send the following sequential values in the form of ; down movement, stop, up movement and stop. The movement aspect of shutter or slat angle adjustment aspect are always depend on previous action. There is a push button status object to prevent sending wrong commands to bus line and the current values of the object can be updated by the devices at the same KNX bus line. This object must be connected to actuator’s status parameter via related group address.

Shutter / blinds circuit control with 2 buttons ; 2 buttons must be used for this option. If both buttons are configured, with long press action the shutter can be moved up or down and with short press action the movement stops or slat angle step movement can be configured. The minimum time to detect the long press action is configured via parameter. Every command controls the buttons defined as “Up” or “Down” via the “Direction” parameter. When short pressed to button configured as “up”, it sends “up” value to bus line, and when short pressed to the button configured as “down”, it sends “down” value to bus line.

5.2.4.1. Parameters List

PARAMETERS	DESCRIPTION	VALUES
Control mode	<p>This parameter is used to configure the shutter / blinds function as “1 button toggle” or “2 buttons up / down”.</p> <p>1 Button toggle : At every time of short press, the push button will send the following sequential values in the form of ; “down”, “stop”, “up” and “stop”.</p> <p>2 Buttons up / down : 2 individual push buttons are used for “up” and “down” commands. According to direction configured before, when short pressed to buttons the “step / stop” event occurs and when long pressed, “up” or “down” event occurs.</p>	<p>1 Button toggle</p> <p>2 Buttons up / down</p>
Direction*¹	<p>This parameter is used to configure up or down operation of the shutter / blinds function.</p>	<p>Up</p> <p>Down</p>
Long press duration*²	<p>This parameter determines the minimum value to detect long press action.</p>	<p>0.4 sec</p> <p>0.5 sec</p> <p>0.6 sec</p> <p>0.7 sec</p> <p>0.8 sec</p> <p>0.9 sec</p> <p>1.0 sec</p>
Push button locking	<p>This parameter determines whether the push button lock is enabled with an additional locking object. When this function used, the locked push button does not send any data to the bus line.</p> <p>Disabled : With this option, device lock is disabled permanently.</p> <p>Lock on value 0 : When a logic 0 value is send to push button locking object, the push button will be locked.</p> <p>Lock on value 1 : When a logic 1 value is send to push button locking object, the push button will be locked.</p>	<p>Disabled</p> <p>Lock on value 0</p> <p>Lock on value 1</p>

Locking after voltage failure*²	<p>Previous value : Push button takes the value at before the voltage failure status.</p> <p>Locking enabled : Even if the push button is not locked before voltage failure, the button will be locked after voltage failure.</p> <p>Locking disabled : Even if the push button is locked before voltage failure, the button will not be locked after voltage failure.</p>	<p>Previous value</p> <p>Locking enabled</p> <p>Locking disabled</p>
Behaviour at beginning of locking*²	<p>This parameter allows to change status of the push button or, at the beginning of lock status transition, it saves the assigned “on” or “off” values.</p>	<p>No reaction – Last state</p> <p>On</p> <p>Off</p>
Behaviour at end of locking*²	<p>This parameter allows to change status of the push button or, at the end of lock status transition, it saves the assigned “on” or “off” values.</p>	<p>No reaction – Last state</p> <p>On</p> <p>Off</p>
LED configuration	<p>This parameter allows to control LED status of the button.</p> <p>Always on : The button LED is always on whether button is pressed .</p> <p>Always off : The button LED is always off whether button is pressed or not.</p> <p>On press / On release : When the push button is pressed or released, the configured color of push button LED is turned on.</p> <p>Led status object : LED’s control is done via led status object.</p>	<p>Always on</p> <p>Always off</p> <p>On press / On release</p> <p>LED status object</p>
LED color on press*³	<p>This parameter allows to control button LED when push button is pressed.</p>	<p>White (Red, Green, Blue, White, Off)</p>
LED color on release*³	<p>This parameter allows to control button LED when push button is released.</p>	<p>Off (Red, Green, Blue, White, Off)</p>
Release delay (sec) *³	<p>This parameter determines a release delay for controlling the button LED when push button is released.</p>	<p>0 (0...255)</p>
LED color for on*⁴	<p>LED color is selected by this parameter when the status is “ON”.</p>	<p>White (Red, Green, Blue, White)</p>
LED color for off*⁴	<p>LED color is selected by this parameter when the status is “OFF”.</p>	<p>Off (Red, Green, Blue, White, Off)</p>

Polarity*⁴	LED's polarity is selected by this parameter.	Normal Inverted
------------------------------	---	---------------------------

¹This parameter is only visible, when the parameter "Control mode" is set to "2 Buttons up / down".

²This parameter is only visible, when the parameter "Push button locking" is set to "Lock on value 0" or "Lock on value 1".

³ This parameter is only visible, when the parameter "LED configuration" is set to "On press / On release".

⁴ This parameter is only visible, when the parameter "LED configuration" is set to "LED status object".

5.2.4.2. Objects List

The following objects can be used via shutter / blinds function.

Object Name	Function	Type	Flags
Button X – Slat Angle / Stop	1 – On / 0 – Off	1 bit	CRT

Stop telegram will be sent via this object connected to related group address.

Button X – Up / Down	0 – Step Up / 1 – Step Down	4 bit	CWT
----------------------	-----------------------------	-------	-----

Up and down telegrams will be sent via this object connected to related group address.

Button X – Up / Down Status	0 – Step Up / 1 – Step Down Status	4 bit	CWT
-----------------------------	------------------------------------	-------	-----

This object can only be seen when "1 Button toggle" control mode is selected. Output status is shown via this object connected to related group address.

Button X – Locking	0 – Disable / 1 – Enable	1 bit	CWT
--------------------	--------------------------	-------	-----

This object appears only when the locking function is enabled. Via the related group address, it is possible to lock the push button by configuration is done before.

Button X – LED Status	1 – On / 0 – Off	1 bit	CWT
-----------------------	------------------	-------	-----

This object appears only when the LED configuration parameter is selected as LED status object. It is possible to control the push button LED by configuration is done before.

5.2.5. Value

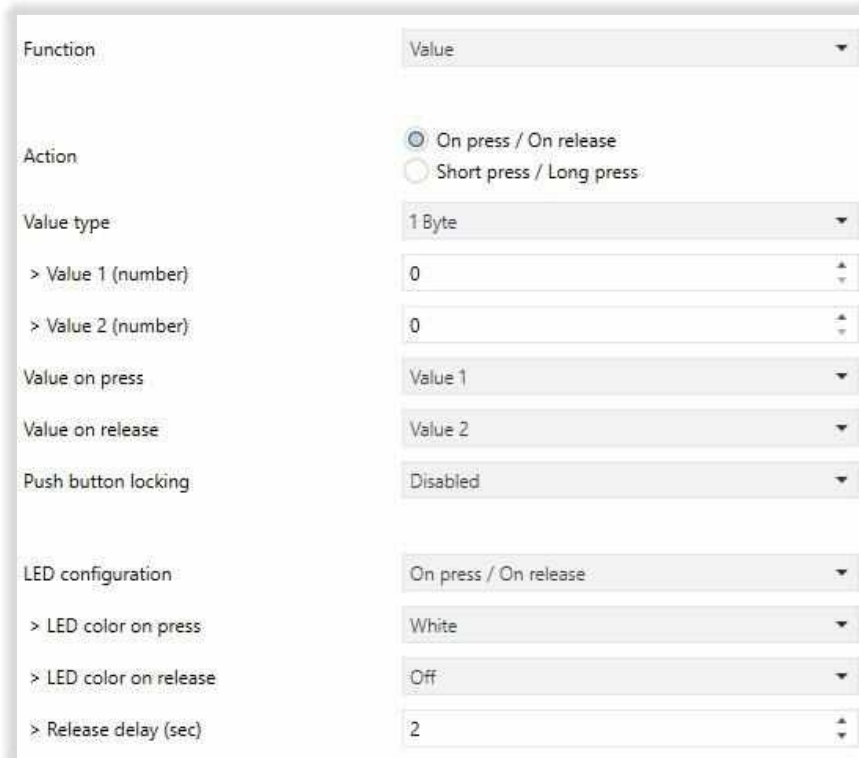

The screenshot displays a configuration window for a button function. The 'Function' dropdown is set to 'Value'. Under 'Action', the 'On press / On release' radio button is selected. 'Value type' is set to '1 Byte'. 'Value 1 (number)' and 'Value 2 (number)' are both set to '0'. 'Value on press' is set to 'Value 1' and 'Value on release' is set to 'Value 2'. 'Push button locking' is set to 'Disabled'. Under 'LED configuration', the 'On press / On release' dropdown is selected, 'LED color on press' is 'White', and 'LED color on release' is 'Off'. 'Release delay (sec)' is set to '2'.

Fig 14 : Value Function Configuration

This function is used to send the value or values previously defined by the parameters to the button. It is possible to choose up to 5 different types of data point types.

1 – Byte Value	Used for 1 – byte(0...255) data sending or to activate scene execute functions.
2 – Byte Value	Used for 2 – byte(0...65535) data sending.
Percentage	Used for 1 – byte percentage value.sending.
Temperature	Used for 2 – byte temperature value sending.
Luminosity	Used for 2 – byte lux value sending.

5.2.5.1. Parameters List

PARAMETRE	AÇIKLAMA	DEĞERLER
Action	<p>This parameter determines the operating status of the button.</p> <p>On press / On release : The value is sent when the button is pressed or released.</p> <p>Short press / Long press : The value is sent when button is short pressed or long pressed.</p>	<p>On press / On release</p> <p>Short press / Long press</p>
Long press duration (sec)*1	<p>This parameter determines the minimum value to detect long press action.</p>	<p>3,0 (0.5, 0.6, 0.7, 0.8, 0.9, 1.0, 1.5, 2.0, 2.5, 3.0, 3.5, 4.0, 4.5, 5.0, 5.5, 6.0, 6.5, 7.0, 7.5, 8.0, 8.5, 9.0, 9.5, 10.0)</p>
Value type	<p>This parameter determines the value type will be sent.</p> <p>1 – Byte Value : (0...255) 0</p> <p>2 – Byte Value : (0...65535) 0</p> <p>Percentage : 1 byte in steps of 1. (0...100%) 0</p> <p>Temperature : 2 byte in steps of 0.5 (0.0...50.0°C) 20.0°C</p> <p>Luminosity : 2 byte in steps of 50.0 (0...1000 lux) 300 lux</p>	<p>1 – Byte</p> <p>2 – Byte</p> <p>Percentage</p> <p>Temperature</p> <p>Luminosity</p>
Value 1,2 (number, %, °C, lux)	<p>This parameter determines the value will be sent.</p>	<p>(0...255) 0</p> <p>(0...65535) 0</p> <p>(0.0...50.0°C) 20.0°C</p> <p>(0...1000 lux) 300 lux</p>
Value on short press	<p>This parameter determines which value will be sent by short press action.</p>	<p>None</p> <p>Value 1</p> <p>Value 2</p> <p>Value 1 & Value 2</p>

Value on long press	This parameter determines which value will be sent by long press action.	None Value 1 Value 2 Value 1 & Value 2
Push button locking	This parameter determines whether the push button lock is enabled with an additional locking object. When this function used, the locked push button does not send any data to the bus line. Disabled : With this option, device lock is disabled permanently. Lock on value 0 : When a logic 0 value is send to push button locking object, the push button will be locked. Lock on value 1 : When a logic 1 value is send to push button locking object, the push button will be locked.	Disabled Lock on value 0 Lock on value 1
Locking after voltage failure*2	Previous value : Push button takes the value at before the voltage failure status. Locking enabled : Even if the push button is not locked before voltage failure, the button will be locked after voltage failure. Locking disabled : Even if the push button is locked before voltage failure, the button will not be locked after voltage failure.	Previous value Locking enabled Locking disabled
Behaviour at beginning of locking*2	This parameter allows to change status of the push button or, at the beginning of lock status transition, it saves the assigned “on” or “off” values.	No reaction – Last state Value 1 Value 2 Value 1 & Value 2
Behaviour at end of locking*2	This parameter allows to change status of the push button or, at the end of lock status transition, it saves the assigned “on” or “off” values.	No reaction – Last state Value 1 Value 2 Value 1 & Value 2

LED configuration	<p>This parameter allows to control LED status of the button.</p> <p>Always on : The button LED is always on whether button is pressed .</p> <p>Always off : The button LED is always off whether button is pressed or not.</p> <p>On press / On release : When the push button is pressed or released, the push button LED is on or off.</p> <p>Led status object : LED's control is done via led status object.</p>	<p>Always on</p> <p>Always off</p> <p>On press / On release</p> <p>LED status object</p>
LED color on press^{*3}	This parameter allows to control button LED when push button is pressed.	White (Red, Green, Blue, White, Off)
LED color on release^{*3}	This parameter allows to control button LED when push button is released.	Off (Red, Green, Blue, White, Off)
Release delay (sec) ^{*3}	This parameter determines a release delay for controlling the button LED when push button is released.	0 (0...255)
LED color for on^{*4}	LED color is selected by this parameter when the status is "ON".	White (Red, Green, Blue, White)
LED color for off^{*4}	LED color is selected by this parameter when the status is "OFF".	Off (Red, Green, Blue, White, Off)
Polarity^{*4}	LED's polarity is selected by this parameter.	<p>Normal</p> <p>Inverted</p>

¹This parameter is only visible, when the parameter "Action" is set to "Short press / Long press".

²This parameter is only visible, when the parameter "Push button locking" is set to "Lock on value 0" or "Lock on value 1".

³This parameter is only visible, when the parameter "LED configuration" is set to "On press / On release".

⁴This parameter is only visible, when the parameter "LED configuration" is set to "LED status object".

5.2.5.2. Objects List

The following objects can be used via value function.

Object Name	Function	Type	Flags
Button X – Value	1 byte / Percentage	1 byte	CRTU

This object can be either 1 byte (0 – 255) or a percentage value. Values will be sent via this object connected to related group address.

Button X – Value	Temperature(Celcius) / 2 byte / Luminosity(Lux)	2 byte	CRTU
------------------	--	--------	------

This object can be 2 byte (0 – 65535), temperature(°C) or luminosity value. Values will be sent via this object connected to related group address.

Button X – Locking	0 – Disable / 1 – Enable 1 – Disable / 0 – Enable	1 bit	CRWTU
--------------------	--	-------	-------

This object appears only when the locking function is enabled. Via the related group address, it is possible to lock the push button by configuration is done before.

Button X – LED Status	Status	1 bit	CRWTU
-----------------------	--------	-------	-------

This object appears only when the LED configuration parameter is selected as LED status object. It is possible to control the push button LED by configuration is done before.

5.2.6. 2 – Channel Mode

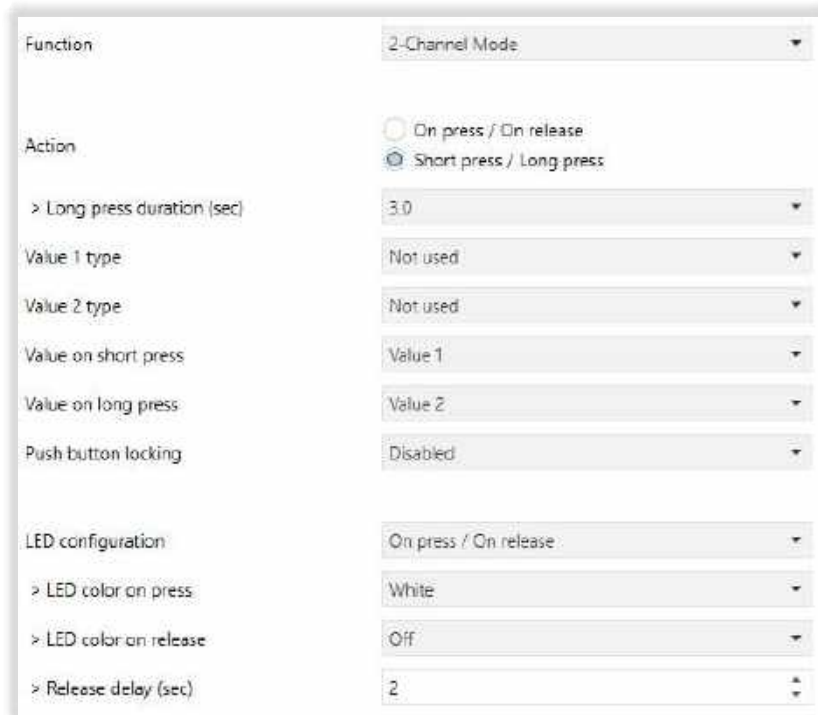

Fig 15 : 2 Channel Mode Function Configuration

2 – channel mode, is used to perform two different functions by using the same button on the device. All functions which can be defined on push buttons are shown below.

5.2.6.1. Parameters List

PARAMETERS	DESCRIPTION	VALUES
Action	<p>This parameter determines the operating status of the button.</p> <p>On press / On release : The value is sent when the button is pressed or released.</p> <p>Short press / Long press : The value is sent when button is short pressed or long pressed.</p>	<p>On press / On release</p> <p>Short press / Long press</p>

Long press duration (sec)*1	This parameter determines the minimum value to detect long press action.	3,0 (0.5, 0.6, 0.7, 0.8, 0.9, 1.0, 1.5, 2.0, 2.5, 3.0, 3.5, 4.0, 4.5, 5.0, 5.5, 6.0, 6.5, 7.0, 7.5, 8.0, 8.5, 9.0, 9.5, 10.0)
Value 1, 2 type	This parameter determines the value type will be sent. On : On telegram Off : Off telegram Toggle : Sends Inverted value of the current one. 1 – Byte : (0...255) 0 2 – Byte : (0...65535) 0 Percentage : 1 byte (0...100%) 0 Temperature : 2 byte 0.5 (0.0...50.0°C) 20.0°C Luminosity : 2 byte (0...1000 lux) 300 lux	Not used On Off Toggle 1 – Byte 2 – Byte Percentage Luminosity
Value 1,2 (number, %, °C, lux)	This parameter determines the value will be sent.	(0...255) 0 (0...65535) 0 (0.0...50.0°C) 20.0°C (0...1000 lux) 300 lux
Value on short press	This parameter determines which value will be sent by short press action.	None Value 1 Value 2 Value 1 & Value 2
Value on long press	This parameter determines which value will be sent by long press action.	None Value 1 Value 2 Value 1 & Value 2

Push button locking	<p>This parameter determines whether the push button lock is enabled with an additional locking object. When this function used, the locked push button does not send any data to the bus line.</p> <p>Disabled : With this option, device lock is disabled permanently.</p> <p>Lock on value 0 : When a logic 0 value is send to push button locking object, the push button will be locked.</p> <p>Lock on value 1 : When a logic 1 value is send to push button locking object, the push button will be locked.</p>	Disabled Lock on value 0 Lock on value 1
Locking after voltage failure*²	<p>Previous value : Push button takes the value at before the voltage failure status.</p> <p>Locking enabled : Even if the push button is not locked before voltage failure, the button will be locked after voltage failure.</p> <p>Locking disabled : Even if the push button is locked before voltage failure, the button will not be locked after voltage failure.</p>	Previous value Locking enabled Locking disabled
Behaviour at beginning of locking*²	<p>This parameter allows to change status of the push button or, at the beginning of lock status transition, it saves the assigned “on” or “off” values.</p>	No reaction – Last state Value 1 Value 2 Value 1 & Value 2
Behaviour at end of locking*²	<p>This parameter allows to change status of the push button or, at the end of lock status transition, it saves the assigned “on” or “off” values.</p>	No reaction – Last state Value 1 Value 2 Value 1 & Value 2

LED configuration	<p>This parameter allows to control LED status of the button.</p> <p>Always on : The button LED is always on whether button is pressed.</p> <p>Always off : The button LED is always off whether button is pressed or not.</p> <p>On press / On release : When the push button is pressed or released, the push button LED is on or off.</p> <p>Led status object : LED's control is done via led status object.</p>	<p>Always on</p> <p>Always off</p> <p>On press / On release</p> <p>LED status object</p>
LED color on press^{*3}	This parameter allows to control button LED when push button is pressed.	White (Red, Green, Blue, White, Off)
LED color on release^{*3}	This parameter allows to control button LED when push button is released.	Off (Red, Green, Blue, White, Off)
Release delay (sec) ^{*3}	This parameter determines a release delay for controlling the button LED when push button is released.	0 (0...255)
LED color for on^{*4}	LED color is selected by this parameter when the status is "ON".	White (Red, Green, Blue, White)
LED color for off^{*4}	LED color is selected by this parameter when the status is "OFF".	Off (Red, Green, Blue, White, Off)
Polarity^{*4}	LED's polarity is selected by this parameter.	<p>Normal</p> <p>Inverted</p>

¹This parameter is only visible, when the parameter "Action" is set to "Short press / Long press".

²This parameter is only visible, when the parameter "Push button locking" is set to "Lock on value 0" or "Lock on value 1".

³This parameter is only visible, when the parameter "LED configuration" is set to "On press / On release".

⁴This parameter is only visible, when the parameter "LED configuration" is set to "LED status object".

5.2.6.2. Objects List

The following objects can be used via 2 – channel mode function.

Object Name	Function	Type	Flags
Button X – Channel 1 Value	1 – On / 0 – Off	1 bit	CWT

This object appears only when channel 1 control type is selected as “On / Off”.

Button X – Feedback Channel 1 Value	1 – On / 0 – Off	1 bit	CRT
-------------------------------------	------------------	-------	-----

This object appears only when channel 1 control type is selected as “toggle”. It shows the current status of value via this object connected to related group address.

Button X – Channel 1 Value	1 byte unsigned value / Percentage (%)	1 byte	CWT
----------------------------	---	--------	-----

This object can be either 1 byte (0 – 255) or a percentage value. Values will be sent via this object connected to related group address.

Button X – Channel 1 Value	Temperature(Celcius) / 2 byte unsigned value / Luminosity(Lux)	2 byte	CWT
----------------------------	---	--------	-----

This object can be 2 byte (0 – 65535), temperature(°C) or luminosity value. Values will be sent via this object connected to related group address.

Button X – Channel 2 Value	1 – On / 0 – Off	1 bit	CWT
----------------------------	------------------	-------	-----

This object appears only when channel 2 control type is selected as “On / Off”.

Button X – Feedback Channel 2 Value	1 – On / 0 – Off	1 byte	CWT
-------------------------------------	------------------	--------	-----

This object appears only when channel 2 control type is selected as “toggle”. It shows the current status of value via this object connected to related group address.

Button X – Channel 2 Value	1 byte unsigned value / Percentage (%)	1 byte	CWT
----------------------------	---	--------	-----

This object can be either 1 byte (0 – 255) or a percentage value. Values will be sent via this object connected to related group address.

Button X – Channel 2 Value	Temperature(Celcius) / 2 byte unsigned value / Luminosity(Lux)	2 byte	CWT
----------------------------	---	--------	-----

This object can be 2 byte (0 – 65535), temperature(°C) or luminosity value. Values will be sent via this object connected to related group address.

Button X – Locking	0 – Disable / 1 – Enable	1 bit	CWT
--------------------	--------------------------	-------	-----

This object appears only when the locking function is enabled. Via the related group address, it is possible to lock the push button by configuration is done before.

Button X – LED Status	1 – On / 0 – Off	1 bit	CWT
-----------------------	------------------	-------	-----

This object appears only when the LED configuration parameter is selected as LED status object. It is possible to control the push button LED by configuration is done before.

5.2.7. Scene

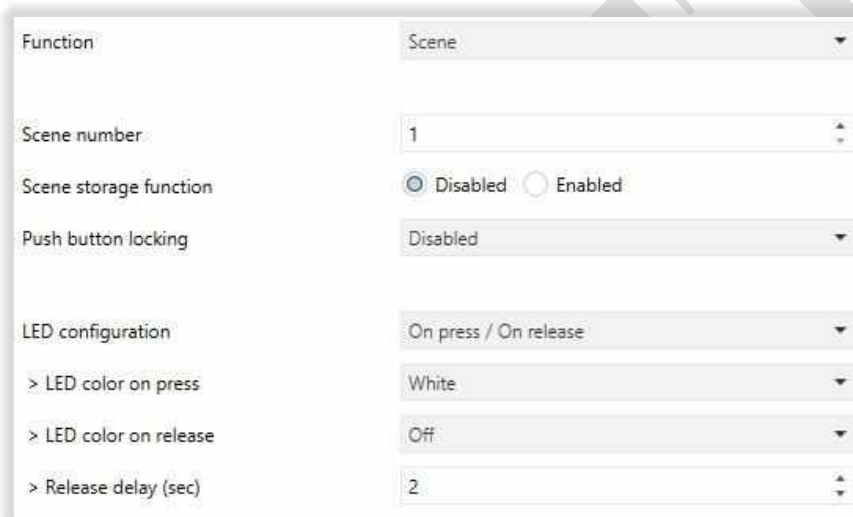

Fig 16 : Scene Function Configuration

The scene function is used to control devices and making pre-registration of their status with the push button which sends command via related group address. This feature allows to register a setting as scene and after a while, when the same settings or conditions are requested each devices can be activated only with 1 command instead of configure them separately.

This feature in the button, sends telegrams that contains “scene run” or “scene register” functions, via the “scene” object. Scene number between 1 and 64 can be selected via the related group address. The scene number that configured in the button must match the scene number configured on the parameters in other devices. Scene number (1 – 64) is used to run the scene using related object. The values are sent via related object must be as in form “Scene Number + 128” for registering the scene feature.



If a scenario number is configured as 2 and it is wished to register this scenario, a value of 130 should be sent (128 + 2). If the scenario number is configured as 24, the value of 152 (128 + 24) should be sent for the scenario registering feature.

For the purpose of running every each scene, a time delayed is defined or not in the parameters should be checked, whether to send with or without time delay or. This feature allows to create dynamic scene arrays which several outputs connected one another with time delay.



After programming with ETS, scene values that are used for parameterization will be written to actuator. This means, related scenes will be erased defined by customer. Hence, before any maintenance, all configurations should be get by programmer and whether the customer wants to use same conditions.

5.2.7.1. Parameters List

PARAMETERS	DESCRIPTION	VALUES
Scene number	This parameter is used to give the scenario number to the generated scenario before.	1 (1...64)
Scene storage function	Scene register function can be enabled via this parameter. To enable this, it is necessary to press long with a predefined number of seconds.	Disabled Enabled
Long press duration (sec)*1	This parameter specifies the minimum time to determine the long press action of a button to register scene.	3,0 (0.5, 0.6, 0.7, 0.8, 0.9, 1.0, 1.5, 2.0, 2.5, 3.0, 3.5, 4.0, 4.5, 5.0, 5.5, 6.0, 6.5, 7.0, 7.5, 8.0, 8.5, 9.0, 9.5, 10.0)
Push button locking	<p>This parameter determines whether the push button lock is enabled with an additional locking object. When this function used, the locked push button does not send any data to the bus line.</p> <p>Disabled : With this option, device lock is disabled permanently.</p> <p>Lock on value 0 : When a logic 0 value is send to push button locking object, the push button will be locked.</p> <p>Lock on value 1 : When a logic 1 value is send to push button locking object, the push button will be locked.</p>	Disabled Lock on value 0 Lock on value 1

Locking after voltage failure* ²	<p>Previous value : Push button takes the value at before the voltage failure status.</p> <p>Locking enabled : Even if the push button is not locked before voltage failure, the button will be locked after voltage failure.</p> <p>Locking disabled : Even if the push button is locked before voltage failure, the button will not be locked after voltage failure.</p>	<p>Previous value</p> <p>Locking enabled</p> <p>Locking disabled</p>
Behaviour at beginning of locking* ²	<p>This parameter allows to change status of the push button or, at the beginning of lock status transition, it saves the assigned “on” or “off” values.</p>	<p>No reaction – Last state</p> <p>Run Scene</p>
Behaviour at end of locking* ²	<p>This parameter allows to change status of the push button or, at the end of lock status transition, it saves the assigned “on” or “off” values.</p>	<p>No reaction – Last state</p> <p>Run Scene</p>
LED configuration	<p>This parameter allows to control LED status of the button.</p> <p>Always on : The button LED is always on whether button is pressed .</p> <p>Always off : The button LED is always off whether button is pressed or not.</p> <p>On press / On release : When the push button is pressed or released, the push button LED is on or off.</p> <p>Led status object : LED’s control is done via led status object.</p>	<p>Always on</p> <p>Always off</p> <p>On press / On release</p> <p>LED status object</p>
LED color on press* ³	<p>This parameter allows to control button LED when push button is pressed.</p>	<p>White (Red, Green, Blue, White, Off)</p>
LED color on release* ³	<p>This parameter allows to control button LED when push button is released.</p>	<p>Off (Red, Green, Blue, White, Off)</p>
Release delay (sec) * ³	<p>This parameter determines a release delay for controlling the button LED when push button is released.</p>	<p>0 (0...255)</p>
LED color for on* ⁴	<p>LED color is selected by this parameter when the status is “ON”.</p>	<p>White (Red, Green, Blue, White)</p>
LED color for off* ⁴	<p>LED color is selected by this parameter when the status is “OFF”.</p>	<p>Off (Red, Green, Blue, White, Off)</p>

Polarity^{*4}	LED's polarity is selected by this parameter.	Normal Inverted
------------------------------	---	---------------------------

^{*1}This parameter is only visible, when the parameter "Scene storage function" is set to "Enabled".

^{*2}This parameter is only visible, when the parameter "Push button locking" is set to "Lock on value 0" or "Lock on value 1".

^{*3}This parameter is only visible, when the parameter "LED configuration" is set to "On press / On release".

^{*4}This parameter is only visible, when the parameter "LED configuration" is set to "LED status object".

5.2.7.2. Objects List

The following objects can be used via scene function.

Object Name	Function	Type	Flags
Button X – Scene	1 – 64 : Run/128+Scene-Storage	1 byte	CRT

Scene telegram will be sent via this object connected to related group address.

Button X – Locking	0 – Disable; 1 – Enable	1 bit	CRT
--------------------	-------------------------	-------	-----

This object appears only when the locking function is enabled. Via the related group address, it is possible to lock the push button by configuration is done before.

Button X – LED Status	1 – On / 0 – Off	1 bit	CRT
-----------------------	------------------	-------	-----

This object appears only when the LED configuration parameter is selected as LED status object. It is possible to control the push button LED by configuration is done before.

5.2.8. Thermostat Extension Control

This function is used to control the thermostat with an external push button. From "thermostat control" section, thermostat operating modes can be configured as "Change between all operating modes" and "Operating mode individual selection". Also, another option is "setpoint control" that is used to increase or decrease the temperature setpoints manually.

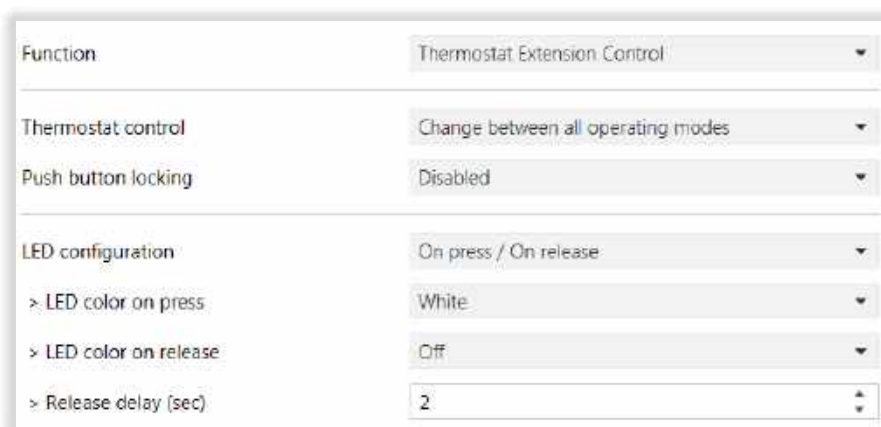

Fig 17 : Thermostat Extension Control Function Configuration

5.2.8.1. Parameters List

PARAMETERS	DESCRIPTION	VALUES
Thermostat Extension Control	<p>This parameter indicates the thermostat control options.</p> <p>Operating mode individual selection : With this option the thermostat can be controlled in 4 different modes. These modes described at “Selection” section.</p> <p>Change between all operating modes : With this option the thermostat changes the operating modes between them.</p> <p>Setpoint control : Thermostat setpoint can be configured via this option.</p>	<p>Operating mode individual selection</p> <p>Change between all operating modes</p> <p>Setpoint control</p>
Selection* ¹	<p>This parameter allows mode selection for thermostat control.</p>	<p>Comfort mode</p> <p>Standby mode</p> <p>Night mode</p> <p>Building protection mode</p>
Modification by pressing* ²	<p>This parameter defines how the button function feature works.</p>	<p>Increase a step</p> <p>Decrease a step</p>
Step for the setpoint control* ²	<p>This parameter determines the step value.</p>	<p>0.5K (0.1K, 0.5K, 1.0K)</p>

Push button locking	<p>This parameter determines whether the push button lock is enabled with an additional locking object. When this function used, the locked push button does not send any data to the bus line.</p> <p>Disabled : With this option, device lock is disabled permanently.</p> <p>Lock on value 0 : When a logic 0 value is send to push button locking object, the push button will be locked.</p> <p>Lock on value 1 : When a logic 1 value is send to push button locking object, the push button will be locked.</p>	<p>Disabled</p> <p>Enabled</p> <p>Lock on value 0</p> <p>Lock on value 1</p>
Locking after voltage failure*³	<p>Previous value : Push button takes the value at before the voltage failure status.</p> <p>Locking enabled : Even if the push button is not locked before voltage failure, the button will be locked after voltage failure.</p> <p>Locking disabled : Even if the push button is locked before voltage failure, the button will not be locked after voltage failure.</p>	<p>Previous value</p> <p>Locking enabled</p> <p>Locking disabled</p>
Behaviour at end of locking*³	<p>This parameter allows to change status of the push button or, at the beginning of lock status transition, it saves the assigned “on” or “off” values.</p>	<p>No reaction – Last state</p> <p>Run Scene</p>
LED configuration	<p>This parameter allows to control LED status of the button.</p> <p>Always on : The button LED is always on whether button is pressed .</p> <p>Always off : The button LED is always off whether button is pressed or not.</p> <p>On press / On release : When the push button is pressed or released, the push button LED is on or off.</p> <p>Led status object : LED’s control is done via led status object.</p>	<p>Always on</p> <p>Always off</p> <p>On press / On release</p> <p>LED status object</p>
LED color on press*⁴	<p>This parameter allows to control button LED when push button is pressed.</p>	<p>White (Red, Green, Blue, White, Off)</p>
LED color on release*⁴	<p>This parameter allows to control button LED when push button is released.</p>	<p>Off (Red, Green, Blue, White, Off)</p>

Release delay (sec) ^{*4}	This parameter determines a release delay for controlling the button LED when push button is released.	0 (0...255)
LED color for on^{*5}	LED color is selected by this parameter when the status is "ON".	White (Red, Green, Blue, White)
LED color for off^{*5}	LED color is selected by this parameter when the status is "OFF".	Off (Red, Green, Blue, White, Off)
Polarity^{*5}	LED's polarity is selected by this parameter.	Normal Inverted

^{*1}This parameter is only visible, when the parameter "Thermostat control" is set to "Operating mode individual selection".

^{*2}This parameter is only visible, when the parameter "Thermostat control" is set to "Setpoint control".

^{*3}This parameter is only visible, when the parameter "Push button locking" is set to "Lock on value 0" or "Lock on value 1".

^{*4}This parameter is only visible, when the parameter "LED configuration" is set to "On press / On release".

^{*5}This parameter is only visible, when the parameter "LED configuration" is set to "LED status object".

5.2.8.2. Objects List

The following objects can be used via thermostat extension control function.

Object Name	Function	Type	Flags
Button X – Operating Mode	1 – Comfort 2 – Standby 3 – Night 4 – Building Protection	1 Byte	CRT

The selected operating mode for push button is controlled via this object connected to related group address.

Button X – Setpoint Temperature	Temperature (°C)	1 Byte	CRT
---------------------------------	------------------	--------	-----

The selected setpoint temperature for push button is controlled via this object connected to related group address.

Button X – Feedback Setpoint Temperature	Temperature (°C) status	1 Byte	CRT
--	-------------------------	--------	-----

This object appears only when thermostat control type is selected as “Setpoint control”. It shows the current status of setpoint temperature via this object connected to related group address.

Button X – Locking	0 – Disable; 1 – Enable	1 Bit	CRT
--------------------	-------------------------	-------	-----

This object appears only when the locking function is enabled. Via the related group address, it is possible to lock the push button by configuration is done before.

Button X – LED Status	1 – On / 0 – Off	1 bit	CRT
-----------------------	------------------	-------	-----

This object appears only when the LED configuration parameter is selected as LED status object. It is possible to control the push button LED by configuration is done before.

5.2.9. Step Switching

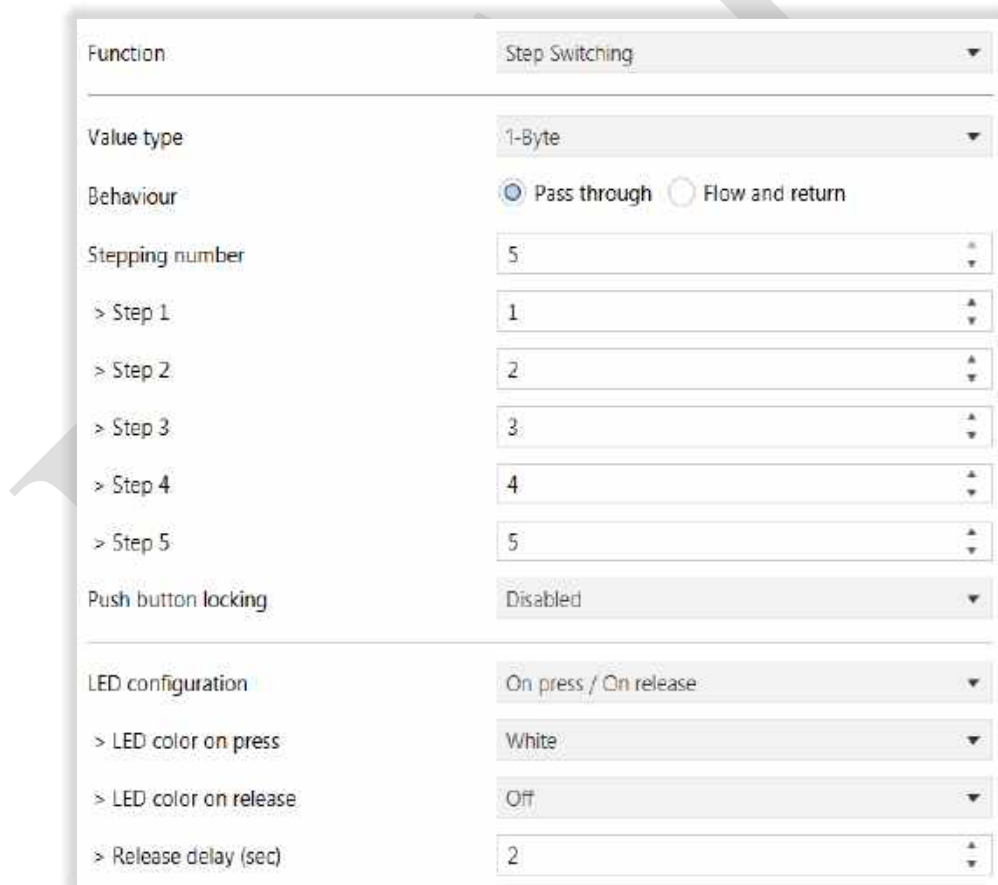

Fig 18 : Sten Switching Function Configuration

Thanks to push button's "step swithing" feature, It is possible to send fixed values as sequential from 1 to 5 different steps in 1 byte, 2 byte, percentage, temperature, luminosity or scene objects, which are configured according to the selected value type.

5.2.9.1. Parameters List

PARAMETER	DESCRIPTION	VALUES
Value type	<p>This parameter determines the type of value will be sent.</p> <p>1 – Byte : (0...255)</p> <p>2 – Byte : (0...65535)</p> <p>Percentage : 1 byte (0...100%)</p> <p>Temperature : 2 byte 0.5 (0.0...50.0°C)</p> <p>Luminosity : 2 byte (0...1000 lux)</p> <p>Scene : 1 byte (1...64)</p>	<p>1 Byte</p> <p>2 Byte</p> <p>Percentage</p> <p>Temperature</p> <p>Luminosity</p> <p>Scene</p>
Behaviour	<p>Determines the transmission option of data that will be sent sequentially , each time the push button is pressed.</p> <p>Pass through : Send values sequentially and returns to initial value and continue. Ex : 1byte 1,2,3,4,5,1,2,3,4,5 repeats as sequential.</p> <p>Flow and return : Send values sequentially and returns to last value and continue. Ex : 1byte 1,2,3,4,5,4,3,2,1 and repeats as sequential.</p>	<p>Pass through</p> <p>Flow and return</p>
Stepping number	Determines the number of data to be sent in sequence.	1 (1...5)
Step 1...5	In this section, the values are entered which will be send sequentially. 1 byte, 2 byte, percentage, temperature, luminosity or scene data types can be sent up to the configured amount of step.	<p>(0...255)</p> <p>(0...65535)</p> <p>(%0...%100)</p> <p>(0...50)</p> <p>(0....1000)</p> <p>(1...64)</p>

Push button locking	<p>This parameter determines whether the push button lock is enabled with an additional locking object. When this function used, the locked push button does not send any data to the bus line.</p> <p>Disabled : With this option, device lock is disabled permanently.</p> <p>Lock on value 0 : When a logic 0 value is send to push button locking object, the push button will be locked.</p> <p>Lock on value 1 : When a logic 1 value is send to push button locking object, the push button will be locked.</p>	<p>Disabled</p> <p>Lock on value 0</p> <p>Lock on value 1</p>
Locking after voltage failure* 1	<p>Previous value : Push button takes the value at before the voltage failure status.</p> <p>Locking enabled : Even if the push button is not locked before voltage failure, the button will be locked after voltage failure.</p> <p>Locking disabled : Even if the push button is locked before voltage failure, the button will not be locked after voltage failure.</p>	<p>Previous value</p> <p>Locking enabled</p> <p>Locking disabled</p>
Behaviour at beginning of locking* 1	<p>This parameter allows to change status of the push button or, at the beginning of lock status transition, it saves the assigned “on” or “off” values.</p>	<p>No reaction – Last state</p> <p>Run Scene</p>
Behaviour at end of locking* 1	<p>This parameter allows to change status of the push button or, at the end of lock status transition, it saves the assigned “on” or “off” values.</p>	<p>No reaction – Last state</p> <p>Run Scene</p>
LED configuration	<p>This parameter allows to control LED status of the button.</p> <p>Always on : The button LED is always on whether button is pressed .</p> <p>Always off : The button LED is always off whether button is pressed or not.</p> <p>On press / On release : When the push button is pressed or released, the configured color of push button LED is turned on.</p> <p>Led status object : LED’s control is done via led status object.</p>	<p>Always on</p> <p>Always off</p> <p>On press / On release</p> <p>LED status object</p>

LED color on press*²	This parameter allows to control button LED when push button is pressed.	White (Red, Green, Blue, White, Off)
LED color on release*²	This parameter allows to control button LED when push button is released.	Off (Red, Green, Blue, White, Off)
Release delay (sec) *²	This parameter determines a release delay for controlling the button LED when push button is released.	0 (0...255)
LED color for on*³	LED color is selected by this parameter when the status is "ON".	White (Red, Green, Blue, White)
LED color for off*³	LED color is selected by this parameter when the status is "OFF".	Off (Red, Green, Blue, White, Off)
Polarity*³	LED's polarity is selected by this parameter.	Normal Inverted

*¹This parameter is only visible, when the parameter "Push button locking" is set to "Lock on value 0" or "Lock on value 1".

*²This parameter is only visible, when the parameter "LED configuration" is set to "On press / On release".

*³This parameter is only visible, when the parameter "LED configuration" is set to "LED status object".

5.2.9.2. Objects List

The following objects can be used via step switching function.

Object Name	Function	Type	Flags
Button X – Step 1 Byte	1 byte unsigned value / Percentage	1 byte	CWT

The 1 byte value sent by this object can be in the range (0 – 255). Values will be sent via this object connected to related group address.

Button X – Step 2 Byte	Temperature (Celcius) / 2 byte unsigned value / Lux	2 byte	CWT
------------------------	--	--------	-----

The 2 byte value sent by this object can be in the range (0 – 65535). Values will be sent via this object connected to related group address.

Button X – Step Percentage	1 byte / Percentage	1 byte	CWT
----------------------------	---------------------	--------	-----

The percentage value sent by this object can be in the range (0 – 100). Values will be sent via this object connected to related group address.

Button X – Step Temperature	Temperature (Celcius) / 2 byte	2 byte	CWT
-----------------------------	--------------------------------	--------	-----

The temperature setpoint value sent by this object can be in the range (0 – 50°C). Values will be sent via this object connected to related group address.

Button X – Step Luminosity	Luminosity (Lux) / 2 byte	2 byte	CWT
----------------------------	---------------------------	--------	-----

The luminosity value sent by this object can be in the range (0 – 1000). Values will be sent via this object connected to related group address.

Button X – Step Scene	Scene control / 1 byte	1 byte	CWT
-----------------------	------------------------	--------	-----

The scene call value sent by this object can be in the range (0 – 64). Values will be sent via this object connected to related group address.

Button X – Locking	0 – Disable / 1 – Enable	1 bit	CWT
--------------------	--------------------------	-------	-----

This object appears only when the locking function is enabled. Via the related group address, it is possible to lock the push button by configuration is done before.

Button X – LED Status	1 – On / 0 – Off	1 bit	CWT
-----------------------	------------------	-------	-----

This object appears only when the LED configuration parameter is selected as LED status object. It is possible to control the push button LED by configuration is done before.

5.3. TEMPERATURE SENSOR PAGE

The screenshot shows a configuration interface for a temperature sensor. It includes several dropdown menus and radio buttons. The settings are as follows:

- Temperature sensor for room controller: Internal
- Internal sensor calibration: 0.0 °C
- Minimum oscillation of internal temperature to send: 0.3 °C
- Sending of internal temperature periodically: Disabled (selected)
- Internal threshold 1: Disabled
- Internal threshold 2: Disabled

Fig 19 : Temperature Sensor Configuration Page

Integrated temperature sensor provides to measure the temperature between -10 °C and $+50\text{ °C}$ with $0,1\text{ °C}$ accuracy. The measured value can be restored to avoid significant environmental interventions such as proximity to heat sources, external wall mounting, chimney effect from pipe that connected to wall mounting box, rising hot air. $\pm 5\text{ °C}$ calibration interval or the the weighted mean value between two different temperature information that selected from below can be used.

- The value measured by integrated sensor.
- The measured value by external temperature sensor that connected to the KNX bus line.

5.3.1. Parameters List

PARAMETERS	DESCRIPTION	VALUES
Temperature sensor for room controller	Connection type of the temperature sensor can be determined by this parameter.	Internal External Internal & External
External sensor calibration* ¹	External sensor's calibration can be made by this parameter.	0,0 (-6,0 ... 6,0)

Internal sensor calibration	Internal sensor's calibration can be made by this parameter.	0,0 (–6,0 ... 6,0)
Weighting factor (Internal / External)*2	Which weighted average ratio will be used for the temperature values taken from internal and external sensors can be determined by this parameter.	100% / 0%, 80% / 20%, 60% / 40%, 40% / 60%, 90% / 10%, 70% / 30%, 50% / 50%, 30% / 70%, 20% / 80%, 0% / 100%, 10% / 90%,
Minimum oscillation of internal temperature to send	This parameter, determines the minimum value change to send the internal temperature information to KNX bus line.	0,3 (0,1 ... 5,0)
Sending of internal temperature periodically	This parameter provides to send the internal temperature value periodically to KNX bus line.	Disabled Enabled
Period of sending (sec)*3	This parameter determines the sending period of the internal temperature information to KNX bus line.	0 (0...255)
Internal threshold 1	First internal threshold value property is activated by this parameter.	Disabled Low High
Lower limit (°C)*4	Lower limit of first internal threshold is determined by this parameter.	5 (–10...50)
Higher limit (°C)*4	Higher limit of first internal threshold is determined by this parameter.	30 (–10...50)
Internal threshold 2	Second internal threshold value property is activated by this parameter.	Disabled Low High
Lower limit (°C) *4	Lower limit of second internal threshold is determined by this parameter.	5 (–10...50)

Higher limit (°C) **4	Higher limit of second internal threshold is determined by this parameter.	30 (-10...50)
------------------------------	--	----------------------

*1This parameter is only visible, when the parameter “Temperature sensor for room controller” is set to “External” or “Internal & External”.

*2This parameter is only visible, when the parameter “Temperature sensor for room controller” is set to “Internal & External”.

*3This parameter is only visible, when the parameter “Sending of interval temperature periodically” is set to “Enabled”.

*4This parameter is only visible, when the parameter “Internal threshold 1” or “Internal threshold 2” is set to “Low” or “High”.

5.3.2. Objects List

Object Name	Function	Type	Flags
Actual Internal Temperature	Temperature (Celcius)	2 Byte	CRTU

This object, provides to measure the actual internal temperature with internal sensor, via connected to related group address.

External Temperature Sensor	Temperature (Celcius)	2 Byte	CRWTU
-----------------------------	-----------------------	--------	-------

This object, provides to measure the actual internal temperature with external sensor, via connected to related group address.

Actual External Temperature	Temperature (Celcius)	2 Byte	CRTU
-----------------------------	-----------------------	--------	------

This object, provides to measure the actual external temperature with external sensor, via connected to related group address.

Actual Internal & External Temperature	Temperature (Celcius)	2 Byte	CRTU
--	-----------------------	--------	------

This object, provides to measure at which ratio the actual internal temperature with external and internal sensors, via connected to related group address.

Internal Temperature Threshold 1	1 – True / 0 – False	1 bit	CRTU
----------------------------------	----------------------	-------	------

This object, provides the use of the first internal threshold value, via connected to related group address.

Internal Temperature Threshold 2	1 – True / 0 – False	1 bit	CRTU
----------------------------------	----------------------	-------	------

This object, provides the use of the second internal threshold value, via connected to related group address.

5.4. ROOM CONTROLLER PAGE

All configurations related to air conditioning control on the iSwitch are described in the sections of this chapter. This parameter page will be shown when it is enabled at the “General” parameter page section. The information about the “General” parameter configuration section is described after the theoretical control type expressions that are given below.

5.4.1. Control Types Theoretical Explanations

Room controller device can be used for only heating, only cooling or heating and cooling. If the room controller is on heating and cooling mode, transition from heating to cooling or vice versa can occur automatically. The thermostat measures the actual temperature of the ambient air and continuously compares it to the set temperature, and the controller automatically calculates whether to send a control signal for heating or cooling.

The control algorithm based on the difference between the desired setpoint temperature values and the measured actual temperature values, processes a command value that can be either percentage or On / Off. The command, periodically or depending on the event, is transmitted to a KNX actuator device via bus line with communication objects.

5.4.1.1. 2 – Points Control

This control algorithm, also known as On / Off, is the most classic and popular one. The algorithm follows a hysteresis cycle, allowing the system to switch On / Off. Hence, 2 switching levels are considered for switching.

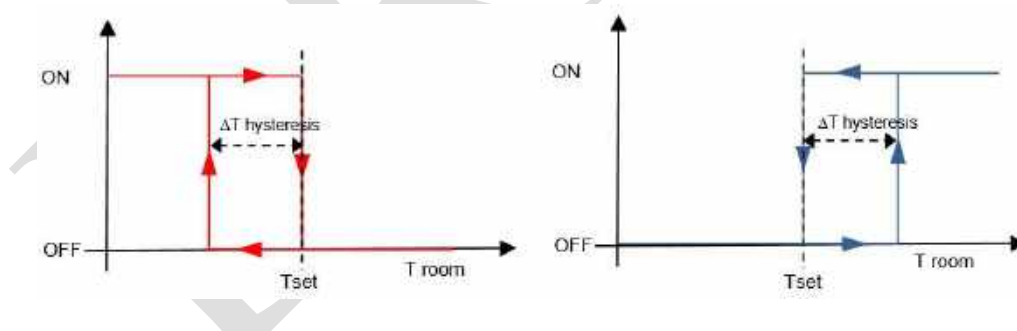

Fig 20 : 2 – Points Control Hysteresis Cycle

Heating mode

When the measured temperature lower than the difference between the setpoint and the hysteresis value ($T_{\text{setpoint}} - \Delta T_{\text{hysteresis}}$), the device activates the heating system by sending KNX command to the actuator that controls the heating system via connected to related group address. When the measured temperature reaches to the setpoint temperature, the device sends a related command and deactivates the heating system. In this way,

there are 2 decision thresholds to activate and deactivate the heating system. First one is the temperature that the device activates the system ($T_{\text{setpoint}} - \Delta T_{\text{hysteresis}}$), second one is the temperature that the device deactivates the heating system (T_{setpoint}).

Cooling mode

When the measured temperature higher than the difference between the setpoint and the hysteresis value ($T_{\text{setpoint}} - \Delta T_{\text{hysteresis}}$), the device activates the heating system by sending KNX command to the actuator that controls the cooling system via connected to related group address. When the measured temperature reaches to the setpoint temperature, the device sends a related command and deactivates the cooling system. In this way, there are 2 decision thresholds to activate and deactivate the cooling system. First one is the temperature that the device activates the system ($T_{\text{setpoint}} + \Delta T_{\text{hysteresis}}$), second one is the temperature that the device deactivates the heating system (T_{setpoint}).

There are 2 different parameters for heating and cooling hysteresis values at ETS programme. Values differs depending on the system type.

5.4.1.2. Pwm Control

The PWM (Pulse Width Modulation) proportional – integral controller allows the digital output to be set to On and Off by sampling an analog control variable within a specified period of time. Controller, runs periodically through a cycle and keeps its output ON for each period in proportion to the value of the control variable. As shown in the below figure, by varying the ratio between the “ON” time and the “OFF” time, the average activation time of the output changes, and as a result the average heating or cooling power supplied by the room changes.

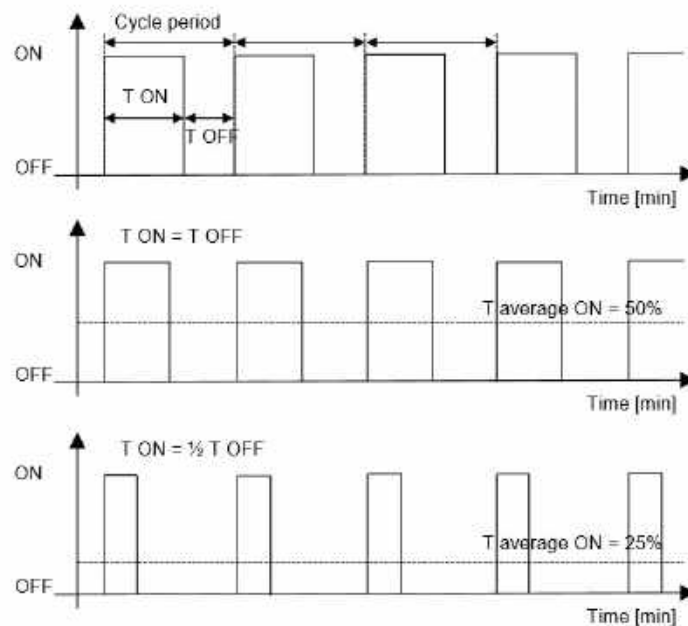

Fig 21 : PWM Control Sampling

This type of control is well suited for use with ON / OFF actuators, such as electrothermal actuators and drives for zone valves, which are less expensive than proportional actuators.

A distinctive advantage of this type of control is that it eliminates the inertia of the system: it allows significant energy savings, because unnecessary interventions on the system introduced by the 2-point control with hysteresis are avoided and only the power required to compensate the losses.

Every time the changes the desired temperature setpoint, the cycle time is interrupted, the control output is reprocessed and the PWM restarts with a new cycle: this allows the system to reach its steady state more quickly.

5.4.1.3. Continuous (PI) Control

Proportional – Integral control (PI control) is explained by the relationship shown below:

$$\text{control variable}(t) = K_p \times \text{error}(t) + K_i \times \int \text{error}(\tau) d\tau \text{ t } 0$$

$$\text{error}(t) = (\text{Setpoint} - \text{Measured temperature}) \text{ in heating}$$

$$\text{error}(t) = (\text{Measured temperature} - \text{Setpoint}) \text{ in cooling}$$

$$K_p = \text{proportional constant}$$

$$K_i = \text{integral constant}$$

The control variable contains integral and proportional (K_i and K_p) constants to eliminate errors. In practice, intuitively generated values are generally used.

Ex 1 :

$$\text{Proportional band } BP [K] = 100 / K_p$$

$$\text{Integral time } T_i [\text{min}] = K_p / K_i$$

The proportional band is the error value that determines the maximum deflection output as 100%.

For example, a regulator with proportional band of 5 K provides a 100% control output when the Setpoint = 20°C and the measured temperature is $\leq 15^\circ\text{C}$ in heating; in the cooling conduction mode, it provides a 100% control output when the Setpoint = 24°C and the measured temperature is $\geq 29^\circ\text{C}$. As shown in the figure, a regulator with a small proportional band tends to provide higher values of the control variable for small errors than a regulator with a higher proportional band.

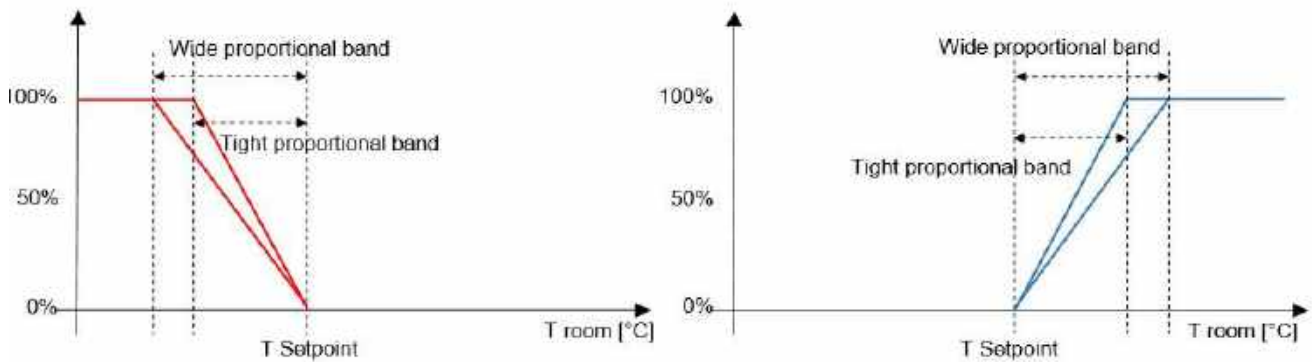

Fig 22 : Continuous PI Control Proportional Band Widths

The integral time is the time required to repeat the value of the control variable of a purely proportional regulator, when the error remains constant in time.

Ex 2 :

For example, with a purely proportional controller in heating and with a value of proportional band of 4 K, if the setpoint is = 20°C and the measured temperature is = 18°C, the control variable assumes the value of 50%. With an integral time = 60 minutes, if the error remains constant, the control variable will take the value = 100% after 1 hour, i.e. a contribution equal to the value given by only proportional contribution will be added to the control variable.

In heating and air conditioning systems, a purely proportional controller is not able to guarantee the achievement of the setpoint. You should always introduce an integrated action for achieving the Setpoint: that is why the integral action is also called automatic reset.

5.4.2. General

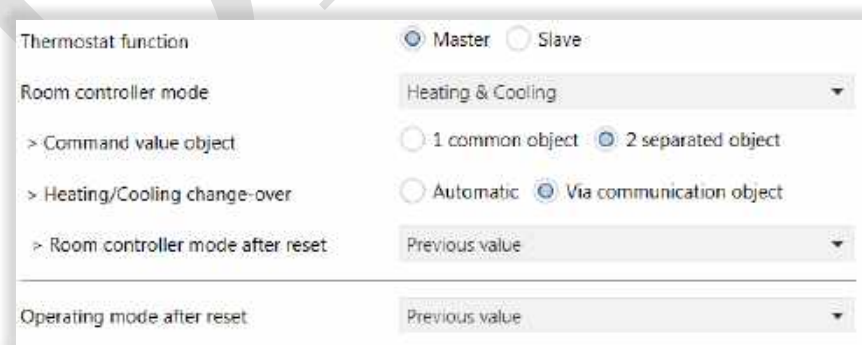

Fig 23 : Room Controller General Configuration Section

The thermostat function can be selected as the “master” controller or “slave” controller in the configuration settings at this section. When the selection is made as the “master” controller, configuration sections and 14 bytes “master room controller” communication object are opened to define the thermostat functions. When the selection is made as the “slave” controller, the configuration sections related to the thermostat functions are closed. Slave controller must be connected to the master controller with the KNX communication object as it will operate as a dependent controller with 14 byte “slave room controller” object. Heating, cooling, heating and cooling operation mode selections, manual or automatic selection of mode switching, and the operation of the room controller after power failure can be set from the this section.

5.4.2.1. Parameters List

PARAMETER	DESCRIPTION	VALUES
Thermostat function	Thermostat function's operating type is determined with this parameter.	Master Slave
Room controller mode	Room controller mode is determined with this parameter.	Heating Cooling Heating & Cooling
Command value object^{*1}	The object types of temperature command values for heating and cooling mode is determined with this parameter.	1 common object 2 seperated object
Heating / Cooling change-over^{*1}	This parameter determines how the heating / cooling transition is made.	Automatic Via communication object
Room controller mode after reset	This parameter determines the room controller mode after the device restarts.	Previous value Heating Cooling
Operating mode after reset	This parameter determines the operating mode of room controller after a reset occurs. Ex : When a power failure occurs.	Previous value Comfort Standby Night Building protection

5.4.2.2. Objects List

Object Name	Function	Type	Flags
Master Room Controller	Master/Slave Communication	14 byte	CRWTU

This object determines which device is the main controller.

Slave Room Controller	Master/Slave Communication	14 byte	CRWTU
-----------------------	----------------------------	---------	-------

This object is used to determine the slave room controller devices.

Operating Mode Switch – Over	1 – Comfort; 2 – Standby; 3 – Night; 4 – Building Protection	1 byte	CRWTU
---------------------------------	---	--------	-------

This object switches over the operating modes with 1 byte value.

Operating Mode Status	1 – Comfort; 2 – Standby; 3 – Night; 4 – Building Protection	1 byte	CRTU
-----------------------	---	--------	------

This object indicates the operating modes status with 1 byte value.

Comfort Mode	1 – Set Mode, 0 – Nothing	1 bit	CRWTU
--------------	---------------------------	-------	-------

The comfort mode activation command is send via this object.

Standby Mode	1 – Set Mode, 0 – Nothing	1 bit	CRWTU
--------------	---------------------------	-------	-------

The standby mode activation command is send via this object.

Night Mode	1 – Set Mode, 0 – Nothing	1 bit	CRWTU
------------	---------------------------	-------	-------

The night mode activation command is send via this object.

Buiding Protection	1 – Set Mode, 0 – Nothing	1 bit	CRWTU
--------------------	---------------------------	-------	-------

The building protection mode activation command is send via this object.

5.4.3. Heating

The device’s operation principle of heating feature as follows : When the measured temperature lower than the setpoint temperature, the device activates the heating system by sending a KNX command to the actuator that controls the heating system via connected to related group address. When the measured temperature reaches to the setpoint temperature, the device sends a related command and deactivates the heating system. The heating feature can be controlled with different types of configuration settings. These configuration settings as follows ;

Selection of the “Heating 2 – Points Control” parameter, 1 bit on / off control.

Selection of the “Heating Pwm Control” parameter, 1 byte proportional – integral control.

Selection of the “Heating Continuous Control” parameter, 1 byte proportional – integral control.

5.4.3.1. Heating 2 – Points Control

When the measured temperature lower than the difference between the setpoint and the hysteresis value ($T_{setpoint} - \Delta T_{hysteresis}$), the device activates the heating system by sending a KNX command to the actuator that controls the heating system via connected to related group address. When the measured temperature reaches to the setpoint temperature, the device sends a related command and deactivates the heating system. In this way, there are 2 decision thresholds to activate and deactivate the heating system. First one is the temperature that the device activates the system ($T_{setpoint} - \Delta T_{hysteresis}$), second one is the temperature that the device deactivates the heating system ($T_{setpoint}$).

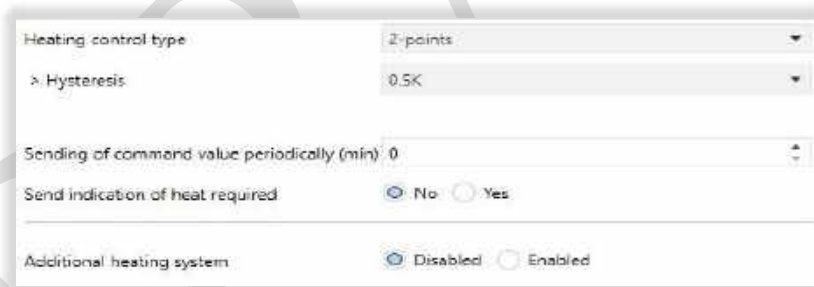

Fig 24 : Heating 2-Points Control Configuration

5.4.3.2. Parameters List

PARAMETER	DESCRIPTION	VALUES
Heating control type	This parameter determines the heating control type.	2 – points Pwm Continuous

Hysteresis	This parameter determines the hysteresis value.	0.5 K (0.1K...2.0K)
Sending of command value periodically (min)	This parameter determines the time period of command value to be sent periodically.	0 (0...100)
Send indication of heat required	This parameter sends status information about whether the heating system is actually working.	No Yes

5.4.3.3. Objects List

Object Name	Function	Type	Flags
Command Value for Heating (2 – points)	1 – On / 0 – Off	1 bit	CRTU

This object controls the heating system by 2 – points control method with 1 byte data as ON / OFF control.

Heat Requirement Indication (2 – points)	Status	1 bit	CRTU
--	--------	-------	------

This object sends the actual status information of the 2-Points controlled heating.

5.4.3.4. Heating Pwm Control

The PWM (Pulse Width Modulation) proportional – integral controller allows the digital output to be set to On and Off by sampling an analog control variable within a specified period of time. Controller, runs periodically through a cycle and keeps its output ON for each period in proportion to the value of the control variable. By varying the ratio between the “ON” time and the “OFF” time of heating system, the average activation time of the output changes, and as a result the average heating power supplied by the room changes.

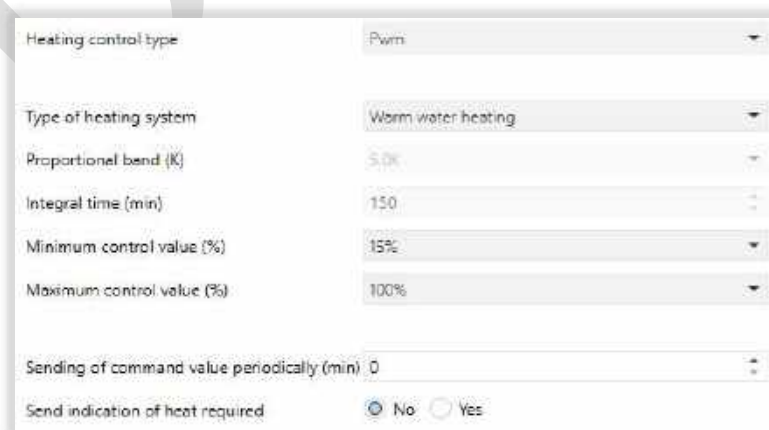

Fig 25 : Heating PWM Control Configuration

5.4.3.5. Parameters List

PARAMETER	DESCRIPTION	VALUES
Type of heating system	This parameter determines the heating system to be controlled.	Warm water heating Electric heating Floor heating Split unit Fan coil User customise
Proportional band (K)	This parameter determines the proportional band.	5.0K (0.5K...10.0K)
Integral time (min)	This parameter determines the integral time.	150 (0...255)
Minimum control value (%)	This parameter determines the output object's minimum control value.	0% (0%, 5%, 10%, 15%, 20%, 25%, 30%)
Maximum control value (%)	This parameter determines the output object's maximum control value.	100% (70%, 75%, 80%, 85%, 90%, 95, 100%)
PWM cycle time (min)	This parameter determines the PWM cycle time.	15 (0...255)
Sending of command value periodically (min)	This parameter determines the time period of command value to be sent periodically.	0 (0...100)
Send indication of heat required	This parameter sends status information about whether the heating system is actually working.	No Yes

5.4.3.6. Objects List

Object Name	Function	Type	Flags
Command for Heating Value (Pwm)	1 – On / 0 – Off	1 bit	CRTU
This object controls the heating system by PWM control method with 1 bit data.			
Command for Heating Value (Pwm)	0% – 100%	1 byte	CRTU

This object controls the heating system by PWM control method with 1 byte data.

Heat Requirement Indication	1 – True / 0 – False	1 bit	CRTU
-----------------------------	----------------------	-------	------

This object sends the actual status information of the PWM controlled heating.

5.4.3.7. Heating Continuous Control

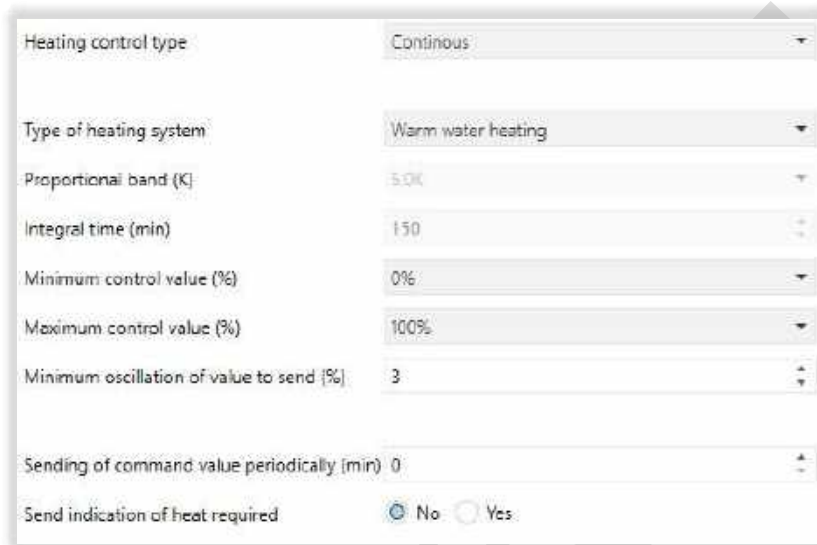

Fig 26 : Heating Continuous Control Configuration

Proportional – Integral control (PI control) is explained by the relationship shown below:

$$\text{control variable}(t) = K_p \times \text{error}(t) + K_i \times \int \text{error}(\tau) d\tau \text{ t } 0$$

$$\text{error}(t) = (\text{Setpoint} - \text{Measured temperature}) \text{ in heating}$$

$$\text{error}(t) = (\text{Measured temperature} - \text{Setpoint}) \text{ in cooling}$$

$$K_p = \text{proportional constant}$$

$$K_i = \text{integral constant}$$

The control variable contains integral and proportional (K_i and K_p) constants to eliminate errors. In practice, intuitively generated values are generally used.

$$\text{Proportional band BP [K]} = 100 / K_p \quad , \quad \text{Integral time Ti [min]} = K_p / K_i$$

The proportional band is the error value that determines the maximum deflection output as 100%.

5.4.3.8. Parameters List

PARAMETER	DESCRIPTION	VALUES
Type of heating system	This parameter determines the heating system to be controlled.	Warm water heating Electric heating Floor heating Split unit Fan coil User customise
Proportional band (K)	This parameter determines the proportional band.	5.0K (0.5K ... 10.0K)
Integral time (min)	This parameter determines the integral time.	150 (0 ... 255)
Minimum control value (%)	This parameter determines the output object's minimum control value.	0% (0%, 5%, 10%, 15%, 20%, 25%, 30%)
Maximum control value (%)	This parameter determines the output object's maximum control value.	100% (70%, 75%, 80%, 85%, 90%, 95%, 100%)
Minimum oscillation of value to send (%)	This parameter determines the minimum oscillation value for the output object to send a value.	3 (0...100)
Sending of command value periodically (min)	This parameter determines the time period of command value to be sent periodically.	0 (0...255)
Send indication of heat required	This parameter sends status information about whether the heating system is actually working.	No Yes

5.4.3.9. Objects List

Object Name	Function	Type	Flags
Command Value for Heating (Continuous)	0% – 100%	1 byte	CRTU

This object controls the continuous PI controlled heating system with 1 byte data.

Heat Requirement Indication	1 – True / 0 – False	1 bit	CRTU
-----------------------------	----------------------	-------	------

This parameter sends status information that the heating system is active or deactive.

5.4.3.10. Additional Heating System

All types of heating controls(2-points, pwm and continuous control) have additional heating system option. The additional heating system works in all control types with the same characteristics. It controls the heating system with hysteresis method. The system activates itself according to the offset and hysteresis configuration. In addition, after a power failure additional system retains its selected value which is selected from the Disabling additional heating parameter(Disabled or Enabled). Besides, there are 2 control type objects these are; switching(1bit) and continuous(1 byte). The continuous one is designed for compatibility with other heating systems.

Fig 27 : Additional Heating System Configuration

5.4.3.11. Parameters List

PARAMETER	DESCRIPTION	VALUES
Additional heating system	This parameter activates the additional heating system.	Disabled Enabled
Control type	This parameter determines the additional heating system's control object type.	Switching (1 – bit) Continuous (1 – byte)
Offset from setpoint to activate*	This parameter determines the difference between the setpoint temperature value and the additional heating system's setpoint temperature value.	0.5K, 1.0K, 1.5K, 2.0K, 2.5K, 3.0K, 3,5K, 4.0K, 5.0K

Hysteresis	This parameter determines the hysteresis value.	0.2K , 0.3K, 0.4K, 0.5K, 0.6K, 0.7K, 0.8K, 0.9K, 1.0K, 1.2K, 1.3K, 0.4K, 1.5K, 1.6K, 1.7K, 1.8K, 1.9K, 2.0K
Sending of control value periodically (min)*¹	This parameter determines the time period of control value to be sent periodically.	0 (0...255)
Disabling additional heating	This parameter allows the additional heating system to be active or passive via KNX bus line.	Disabled Enabled

5.4.3.12. Objects List

Object Name	Function	Type	Flags
Control of Additional Heating	1 – On / 0 – Off	1 bit	CRTU
This object controls the additional heating system with 1 bit data.			
Control of Additional Heating	0% – 100%	1 byte	CRTU
This object controls the additional heating system with 1 byte data.			
Disable Additional Heating	0 – Disable / 1 – Enable	1 bit	CRWTU

This object activates or deactivates the additional heating system.

5.4.4. Cooling

The device's operation principle of cooling feature as follows : When the measured temperature higher than the setpoint temperature, the device activates the cooling system by sending a KNX command to the actuator that controls the cooling system via connected to related group address. When the measured temperature reaches to the setpoint temperature, the device sends a related command and deactivates the cooling system. The cooling feature can be controlled with different types of configuration settings. These configuration settings as follows ;

Selection of the “Heating 2 – Points Control” parameter, 1 bit on / off control.

Selection of the “Heating Pwm Control” parameter, 1 byte proportional – integral control.

Selection of the “Heating Continuous Control” parameter, 1 byte proportional – integral control.

5.4.4.1. Cooling 2 – Points Control

When the measured temperature higher than the difference between the setpoint and the hysteresis value ($T_{\text{setpoint}} + \Delta T_{\text{hysteresis}}$), the device activates the cooling system by sending a KNX command to the actuator that controls the cooling system via connected to related group address. When the measured temperature reaches to the setpoint temperature, the device sends a related command and deactivates the cooling system. In this way, there are 2 decision thresholds to activate and deactivate the cooling system. First one is the temperature that the device activates the cooling system ($T_{\text{setpoint}} + \Delta T_{\text{hysteresis}}$), second one is the temperature that the device deactivates the cooling system (T_{setpoint}).

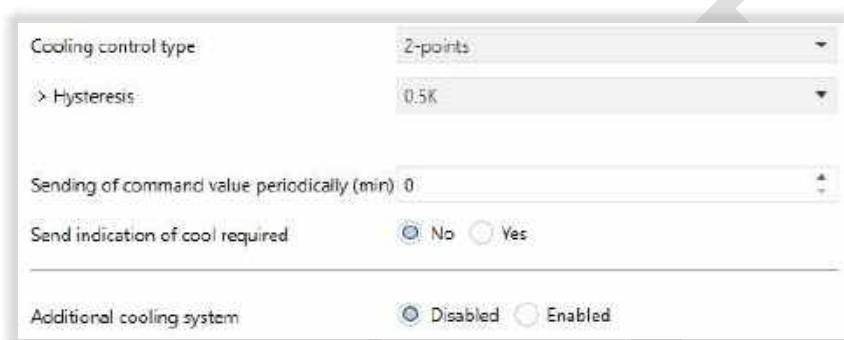

Fig 28 : Cooling 2-Points Control Configuration

5.4.4.2. Parameters List

PARAMETER	DESCRIPTION	VALUES
Cooling control type	This parameter determines the cooling control type.	2 – points Pwm Continuous
Hysteresis	This parameter determines the hysteresis value.	0.5K (0.1K...2.0K)
Sending of command value periodically (min)	This parameter determines the time period of command value to be sent periodically.	0 (0...100)
Send indication of cool required	This parameter sends status information about whether the cooling system is actually working.	No Yes

5.4.4.3. Objects List

Object Name	Function	Type	Flags
Command Value for Cooling (2 – points)	1 – On / 0 – Off	1 bit	CRTU

This object controls the cooling system by 2 – points control method with 1 byte data as ON / OFF control.

Cool Requirement Indication	Status	1 bit	CRTU
-----------------------------	--------	-------	------

This object sends the actual status information of the 2-Points controlled cooling.

5.4.4.4. Cooling Pwm Control

The PWM (Pulse Width Modulation) proportional – integral controller allows the digital output to be set to On and Off by sampling an analog control variable within a specified period of time. Controller, runs periodically through a cycle and keeps its output ON for each period in proportion to the value of the control variable. By varying the ratio between the “ON” time and the “OFF” time of heating system, the average activation time of the output changes, and as a result the average heating power supplied by the room changes.

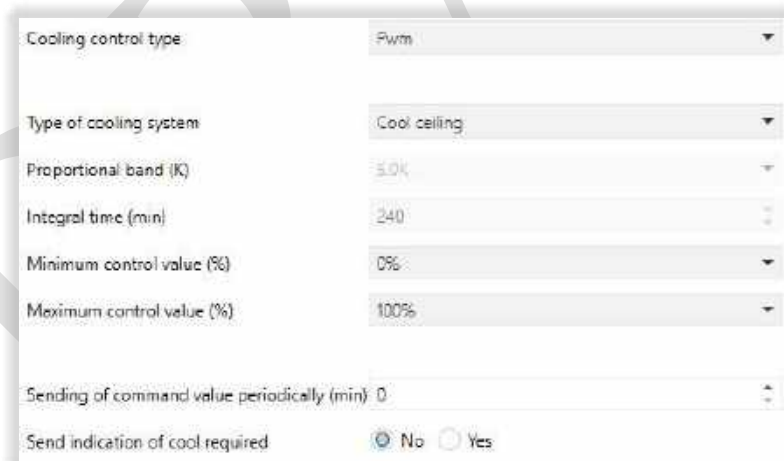

Fig 29 : Cooling PWM Control Configuration

5.4.4.5. Parameters List

PARAMETER	DESCRIPTION	VALUE
Type of cooling system	This parameter determines the cooling system to be controlled.	Cool ceiling Split unit Fan coil User customize
Proportional band (K)	This parameter determines the proportional band.	5.0K (0.5K...10.0K)
Integral time (min)	This parameter determines the integral time.	240 (0...255)
Minimum control value (%)	This parameter determines the output object's minimum control value.	0% (0%, 5%, 10%, 15%, 20%, 25%, 30%)
Maximum control value (%)	This parameter determines the output object's maximum control value.	100% (70%, 75%, 80%, 85%, 90%, 95%, 100%)
PWM cycle time (min)	This parameter determines the PWM cycle time.	15 (0...255)
Sending of command value periodically (min)	This parameter determines the time period of command value to be sent periodically.	0 (0...100)
Send indication of cool required	This parameter sends status information about whether the cooling system is actually working.	No Yes

5.4.4.6. Objects List

Object Name	Function	Type	Flags
Command Value for Cooling (Pwm)	1 – On / 0 – Off	1 bit	CRTU
This object controls the cooling system by PWM control method with 1 bit data.			
Command Value for Cooling (Pwm)	0% – 100%	1 byte	CRTU

This object controls the cooling system by PWM control method with 1 byte data.

Cool Requirement Indication	1 – True / 0 – False	1 bit	CRTU
-----------------------------	----------------------	-------	------

This object sends the actual status information of the PWM controlled cooling.

5.4.4.7. Cooling Continuous Control

Fig 30 : Cooling Continuous Control Configuration

Proportional – Integral control (PI control) is explained by the relationship shown below:

$$control\ variable(t) = Kp \times error(t) + Ki \times \int error(\tau) d\tau \ t \ 0$$

$$error(t) = (Setpoint - Measured\ temperature) \ in\ heating$$

$$error(t) = (Measured\ temperature - Setpoint) \ in\ cooling$$

$$Kp = proportional\ constant$$

$$Ki = integral\ constant$$

The control variable contains integral and proportional (Ki and Kp) constants to eliminate errors. In practice, intuitively generated values are generally used.

$$Proportional\ band\ BP\ [K] = 100 / Kp \quad , \quad Integral\ time\ Ti\ [min] = Kp / Ki$$

The proportional band is the error value that determines the maximum deflection output as 100%.

5.4.4.8. Parameters List

PARAMETER	DESCRIPTION	VALUES
Type of cooling system	This parameter determines the cooling system to be controlled.	Cooling ceiling Split unit Fan coil User customize
Proportional band (K)	This parameter determines the proportional band.	5.0K (0.5K...10.0K)
Integral time (min)	This parameter determines the integral time.	240 (0...255)
Minimum control value (%)	This parameter determines the output object's minimum control value.	0% (0%, 5%, 10%, 15%, 20%, 25%, 30%)
Maximum control value (%)	This parameter determines the output object's maximum control value.	100% (70%, 75%, 80%, 85%, 90%, 95%, 100%)
Minimum oscillation of value to send (%)	This parameter determines the minimum oscillation value for the output object to send a value.	3 (0...100)
Sending of command value periodically (min)	This parameter determines the time period of command value to be sent periodically.	0 (0...255)
Send indication of cool required	This parameter sends status information about whether the cooling system is actually working.	No Yes

5.4.4.9. Objects List

Object Name	Function	Type	Flags
Command Value for Cooling (Continuous)	0% – 100%	1 byte	CRTU

This object controls the continuous PI controlled cooling system with 1 byte data.

Cool Requirement Indication	1 – True / 0 – False	1 bit	CRTU
-----------------------------	----------------------	-------	------

This parameter sends status information that the cooling system is active or deactive.

5.4.4.10. Additional Cooling System

All types of cooling controls(2-points, pwm and continuous control) have additional cooling system option. The additional cooling system works in all control types with the same characteristics. It controls the cooling system with hysteresis method. The system activates itself according to the offset and hysteresis configuration. In addition, after a power failure additional system retains its selected value which is selected from the “Disabling additional cooling” parameter(Disabled or Enabled). Besides, there are 2 control type objects these are; switching(1bit) and continuous(1 byte). The continuous one is designed for compatibility with other cooling systems.



Fig 31 : Additional Cooling System Configuration

5.4.4.11. Parameters List

PARAMETER	DESCRIPTION	VALUE
Additional Cooling system	This parameter activates the additional cooling system.	Disabled Enabled
Control type	This parameter determines the additional cooling system’s control object type.	Switching (1 – bit) Continuous (1 – byte)
Offset from setpoint to activate	This parameter determines the difference between the setpoint temperature value and the additional cooling system’s setpoint temperature value.	0.5K, 1.0K, 1.5K, 2.0K, 2.5K, 3.0K, 3.5K, 4.0K, 5.0K
Hysteresis	This parameter determines the hysteresis value.	0.2K, 0.3K, 0.4K, 0.5K, 0.6K, 0.7K, 0.8K, 0.9K, 1.0K, 1.2K, 1.3K, 0.4K, 1.5K, 1.6K, 1.7K, 1.8K, 1.9K, 2.0K,

Sending of control value periodically (min)	This parameter determines the time period of control value to be sent periodically.	0 (0...255)
Disabling additional cooling	This parameter allows the additional cooling system to be active or passive via KNX bus line.	Disabled Enabled

5.4.4.12. Objects List

Object Name	Function	Type	Flags
Control of Additional Cooling	1 – On / 0 – Off	1 bit	CRTU
This object controls the additional cooling system with 1 bit data.			
Control of Additional Cooling	0% – 100%	1 byte	CRTU
This object controls the additional cooling system with 1 byte data.			
Disable Additional Cooling	0 – Disable / 1 – Enable	1 bit	CRWTU

This object activates or deactivates the additional cooling system.

5.4.5. Heating & Cooling

Heating & Cooling mode is generally used when there are 2 different heating and cooling sources or only 1 source that have both heating and cooling ability together. If the heating/cooling sources are different, command value object parameter should be selected as “2 separated object”. However, if heating and cooling is obtained from the same source, command value object parameter should be selected as “1 common object”. Additionally, in this mode, distinction is made whether the switch-over between heating and cooling is to be effected automatically or in a controlled way through the communication object.

In automatic switch-over option: for the heating, the controller will turn on the heating when the room temperature has fallen below a preset deadband limit. As soon as the room temperature is exceeding the heating setpoint, the control will turn off the heating in the heating & cooling mode. For the cooling, the controller will turn on the cooling system when the room temperature has exceeded a preset deadband limit. As soon as the room temperature is reaching above the cooling setpoint, the control will turn off the cooling system in the heating & cooling mode.

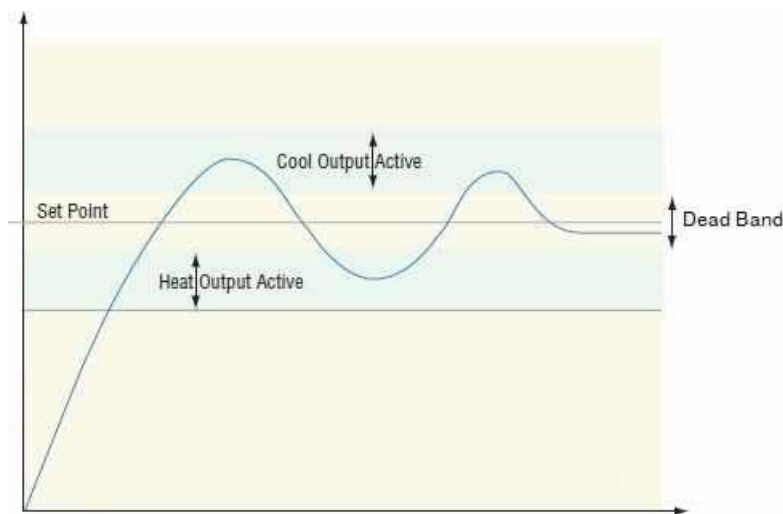

Fig 32 : Heating & Cooling Mode Dead Band

In via communication object option: In this option, there is no deadband concept compared to automatic option. The main difference between automatic and communication object option; the mode switch-over between modes is made by manually.

5.4.5.1. Parameters List

In heating & cooling mode, cooling configurations and heating configurations can be made separately mentioned before. At this section, only extra parameters for this mode are described below.

PARAMETER	DESCRIPTION	VALUES
Thermostat function	Thermostat function's operating type is determined with this parameter.	Master Slave
Room controller mode	Room controller mode is determined with this parameter.	Heating Cooling Heating & Cooling
Command value object*1	The object types of temperature command values for heating and cooling mode is determined with this parameter.	1 common object 2 seperated object
Heating / Cooling change-over*1	This parameter determines how the heating / cooling transition is made.	Automatic Via communication object

Room controller mode after reset	This parameter determines the room controller mode after the device restarts.	Previous value Heating Cooling
---	---	---

5.4.5.2. Objects List

In heating & cooling mode, cooling configurations and heating configurations can be made separately mentioned before. At this section, only extra objects for this mode are described below.

Object Name	Function	Type	Flags
Heating / Cooling Change – Over	1 – Heat; 0 – Cool	1 bit	CRWTU

This object is used to change over the heating / cooling modes.

Heating / Cooling Status	1 – Heat; 0 – Cool	1 bit	CRTU
--------------------------	--------------------	-------	------

Heating / cooling status information is indicated via this object.

Command Value for Heating and Cooling (2 – points)	1 – On / 0 – Off	1 bit	CRTU
--	------------------	-------	------

This object sends commands for the heating and cooling modes by 2 – points on / off control method with 1 bit data.

Command Value for Heating and Cooling (Pwm)	1 – On / 0 – Off	1 bit	CRTU
---	------------------	-------	------

This object sends commands for the heating and cooling modes by pulse width modulation(pwm) control method with 1 bit data.

Command Value for Heating and Cooling (Continuous)	0% – 100%	1 byte	CRTU
--	-----------	--------	------

This object sends commands for the heating and cooling modes by continuous control method with 1 byte data.

Command Value for Heating (2 – points)	1 – On / 0 – Off	1 bit	CRTU
--	------------------	-------	------

This object controls the heating system by 2 – points control method with 1 byte data as ON / OFF control.

Command for Heating Value (Pwm)	1 – On / 0 – Off	1 bit	CRTU
---------------------------------	------------------	-------	------

This object controls the heating system by PWM control method with 1 bit data.

Command for Heating Value (Pwm)	0% – 100%	1 byte	CRTU
---------------------------------	-----------	--------	------

This object controls the heating system by PWM control method with 1 byte data.

Command Value for Heating (Continuous)	0% – 100%	1 byte	CRTU
--	-----------	--------	------

This object controls the continuous PI controlled heating system with 1 byte data.

Command Value for Cooling (2 – points)	1 – On / 0 – Off	1 bit	CRTU
--	------------------	-------	------

This object controls the cooling system by 2 – points control method with 1 byte data as ON / OFF control.

Command Value for Cooling (Pwm)	1 – On / 0 – Off	1 bit	CRTU
---------------------------------	------------------	-------	------

This object controls the cooling system by PWM control method with 1 bit data.

Command Value for Cooling (Pwm)	0% – 100%	1 byte	CRTU
---------------------------------	-----------	--------	------

This object controls the cooling system by PWM control method with 1 byte data.

Command Value for Cooling (Continuous)	0% – 100%	1 byte	CRTU
--	-----------	--------	------

This object controls the continuous PI controlled cooling system with 1 byte data.

5.4.6. Set Points

Sending of setpoint	On change
Maximum manual setpoint adjustment allowed	±3.0 °C
End of manual operation	Reset manual operation object
Behaviour after receiving new mode set point	<input type="radio"/> Reset manual operation <input checked="" type="radio"/> Keep manual operation
Setpoint temperature after power failure	<input checked="" type="radio"/> Previous value <input type="radio"/> Defined in parameter
Setpoints type	<input checked="" type="radio"/> Individual setpoints <input type="radio"/> Dependent setpoints
Heating & Cooling	
Setpoint comfort mode (°C)	21.0 °C
Minimum dead band allowed for change-over	1.0 °C
Heat setpoint standby mode (°C)	19.0 °C
Cool setpoint standby mode (°C)	25.0 °C
Heat setpoint night mode (°C)	15.0 °C
Cool setpoint night mode (°C)	27.0 °C
Setpoint frost protection (°C)	7.0 °C
Setpoint heat protection (°C)	35.0 °C

Fig 33 : Set Points Configuration

Temperature setpoints for heating or cooling modes are configured in this section. The operation modes such as comfort, standby, night and frost protection of “heating”, “cooling” and “heating & cooling” modes can be separately specified from this section. The temperature setpoint value can be configured to send to KNX bus line with 3 different settings such as “Periodically”, “On change” and “Periodically and on change”. Besides, how much the maximum band width setting will be configured for that increasing or decreasing the temperature value manually can be determined. Moreover, it is possible to set which setpoint values will be used when there is a power failure.

5.4.6.1. Parameters List

PARAMETER	DESCRIPTION	VALUES
Sending of setpoint	<p>This parameter allows to send the setpoint temperature value informations.</p> <p>On change : The Temperature value information is sent when the setpoint temperature value changed 1 K.</p> <p>Periodically : The Temperature value information is sent periodically.</p> <p>Periodically and on change : The Temperature value information is sent periodically or when the setpoint temperature value changed 1 K.</p>	<p>On change</p> <p>Periodically</p> <p>Periodically and on change</p>
Period of sending (min)*¹	This parameter determines the time period of setpoint temperature value to be sent periodically.	5 (0...255)
Maximum manual setpoint adjustment allowed	This parameter configures the maximum and minimum limit values for the setpoint temperature value.	<p>+ / - 3.0°C</p> <p>(+ / - 1 °C... + / - 10.0 °C)</p>
End of manual operation	<p>This parameter determines the time to end manual operation.</p> <p>This parameter determines the behavior after receiving the new set mode.</p>	<p>Reset manual operation object</p> <p>30 min, 1hr, 2hr, 3hr, 4hr, 6hr, 9hr, 12hr, 15hr, 18hr, 25hr</p>
Behavior after receiving new mode set	<p>This parameter determines the behaviour after receiving the new set mode.</p> <p>Reset manual operation : The manual operation is reset after the new setting mode is received with this option.</p> <p>Keep manual operation : The manual operation is continued after the new setting mode is received with this option.</p>	<p>Reset manual operation</p> <p>Keep manual operation</p>
Setpoint temperature after power failure	This parameter determines the setpoint temperature after a power failure.	<p>Previous value</p> <p>Defined in parameter</p>
Setpoints type	The desired temperature value can be controlled with individual or dependent setpoints by this parameter.	<p>Individual setpoints</p> <p>Dependent setpoints</p>

Setpoint comfort mode (°C)	The desired temperature value for comfort mode is configured with this parameter.	21.0°C (10.0°C...35.0°C)
Setpoint standby mode (°C)	The desired temperature value for standby mode is configured with this parameter.	19.0°C (10.0°C...35.0°C)
Setpoint night mode (°C)	The desired temperature value for night mode is configured with this parameter.	15.0°C (10.0°C...35.0°C)
Setpoint frost protection (°C)	The desired temperature value for frost protection mode is configured with this parameter.	7.0°C (10.0°C...35.0°C)
Setpoint heat protection (°C)	The desired temperature value for heat protection mode is configured with this parameter.	35.0°C (10.0°C...35.0°C)
Minimum dead band allowed for change – over	When the heating / cooling change – over is configured in automatic mode, the dead bandwidth is can be set with this parameter.	1.0°C (0.5°C...7.0°C)

5.4.6.2. Objects List

Object Name	Function	Type	Flags
Actual Setpoint Temperature	Temperature (Celcius)	2 byte	CRTU
The pre – configured setpoint temperature is obtained with this object.			
Set Manual Setpoint	Temperature (Celcius)	2 byte	CRWTU
The setpoint temperature is configured manually with this object.			
Reset Manual Setpoint Operation	1 – True / 0 – False	1 bit	CRWTU
The setpoint temperature that is desired to configure manually can be reset with this object.			
Setpoint for Comfort	Temperature (Celcius)	2 byte	CRWTU
The setpoint temperature value for comfort mode is configured with this object.			
Setpoint for Heating Standby	Temperature (Celcius)	2 byte	CRWTU
The setpoint temperature value for heating standby mode is configured with this object.			
Setpoint for Heating Night	Temperature (Celcius)	2 byte	CRWTU
The setpoint temperature value for heating night mode is configured with this parameter.			

Setpoint for Cooling Standby	Temperature (Celcius)	2 byte	CRWTU
------------------------------	-----------------------	--------	-------

The setpoint temperature value for cooling standby mode is configured with this parameter.

Setpoint for Cooling Night	Temperature (Celcius)	2 byte	CRWTU
----------------------------	-----------------------	--------	-------

The setpoint temperature value for cooling night mode is configured with this parameter.

Setpoint for Heat Protection	Temperature (Celcius)	2 byte	CRWTU
------------------------------	-----------------------	--------	-------

The setpoint temperature value for heat protection mode is configured with this parameter.

Setpoint for Frost Protection	Temperature (Celcius)	2 byte	CRWTU
-------------------------------	-----------------------	--------	-------

The setpoint temperature value for frost protection mode is configured with this parameter.

5.4.7. Fan

This section contains information about the usage of “Fan Indicator” and “Fan Controller” sections.

5.4.7.1. Fan Indicator

When the parameter “Fan control available” is set to “Enabled” for fan control at the “GENERAL” parameter page, a new subtitle is generated named “Fan Indicator” inside the LCD parameter page. At this section it is possible to make configurations such as, number of fan level (from 1 to 5) can be configured, fan level indicator data type can be determined, fan operating speeds to work according to which limits. Above, The opening page is shown only when the parameter “Fan control available” is set to “Enabled. Additionally, fan indicator is used only for visualization the status information on the LCD screen.

The screenshot shows a configuration window for the Fan Indicator. It contains the following elements:

- Number of fan level:** A numeric input field with the value '5' and a small up/down arrow icon on the right.
- Fan level indicator:** Two radio button options: '1-byte' (which is selected) and 'Individual 1-bit'.
- > Type:** Two radio button options: 'Enumerated' (which is selected) and 'Scaling'.
- Manual/Auto control object:** Two radio button options: '1:Manual / 0:Auto' (which is selected) and '0:Manual / 1:Auto'.

Fig 34 : Fan Indicator Configuration

5.4.7.2. Parameters List

PARAMETER	DESCRIPTION	VALUES
Number of fan level	The number of fan level is determined with this parameter.	3 (1...5)
Fan level indicator	This parameter determines the fan level indicator data type.	1-byte Individual 1-bit
Type	This parameter determines the fan level indicator visualization method.	Enumerated Scaling
Fan level 1 lower limit	The lower limit value of the 1st speed is determined with this parameter.	1 (1...100)
Fan level 2 lower limit* ¹	The lower limit value of the 2nd speed is determined with this parameter.	30 (1...100)
Fan level 3 lower limit* ¹	The lower limit value of the 3rd speed is determined with this parameter.	70 (1...100)
Manual / Auto control object	Manual or automatic fan speed control is selected with this parameter.	1 : Manual / 0 : Auto 0 : Manual / 1 : Auto

*¹ This parameters are only visible according to selected "Number of fan level" parameter value.

5.4.7.3. Objects List

Object Name	Function	Type	Flags
Fan Indicator Scaling	0 – OFF; 1 – Speed 1; 2 – Speed 2; 3 – Speed 3; 4 – Speed 4; 5 – Speed 5	1 byte	CRWTU

This object is used for the fan speed to be displayed on the screen. Fan levels configured to specific limits are displayed on the screen. 5 different fan speed levels can be displayed.

Fan Indicator Enumerated	0 – OFF; 1 – Speed 1; 2 – Speed 2; 3 – Speed 3; 4 – Speed 4; 5 – Speed 5	1 byte	CRWTU
--------------------------	--	--------	-------

This object is used for the fan speed to be displayed on the screen. When the value of 1 is sent fan level is 1, value of 2 sent and the fan level is 2, and so on; the fan level can be determined. A total of 5 different fan speed levels can be determined.

Fan Indicator Auto / Manual	1 – On / 0 – Off	1 bit	CRWTU
--------------------------------	------------------	-------	-------

This object is used to display manual or auto fan speed on the screen.

Fan Indicator Individual Level 1	1 – On / 0 – Off	1 bit	CRWTU
-------------------------------------	------------------	-------	-------

This object is used to display the 1st fan speed level on the screen.

Fan Indicator Individual Level 2	1 – On / 0 – Off	1 bit	CRWTU
-------------------------------------	------------------	-------	-------

This object is used to display the 2nd fan speed level on the screen.

Fan Indicator Individual Level 3	1 – On / 0 – Off	1 bit	CRWTU
-------------------------------------	------------------	-------	-------

This object is used to display the 3rd fan speed level on the screen.

Fan Indicator Individual Level 4	1 – On / 0 – Off	1 bit	CRWTU
-------------------------------------	------------------	-------	-------

This object is used to display the 4th fan speed level on the screen.

Fan Indicator Individual Level 5	1 – On / 0 – Off	1 bit	CRWTU
-------------------------------------	------------------	-------	-------

This object is used to display the 5th fan speed level on the screen.

5.4.7.4. Fan Controller

In addition to the above, if the parameter “Fan control used for room controllers” is set to “Enabled” from the “GENERAL” parameter page, the configuration page that is related to fan control is now opened as “Fan Controller” under the “ROOM CONTROLLER” parameter page instead of the “LCD” parameter page. The image of the configuration page to be opened is shown above. The configuration settings in this section are configured such as, the selection of fan speed level of the device to be used, the fan speed transitions in regard to the percentage value to be changed, the manual or automatic fan speed selections, and all arrangements related to feedback reception of the current fan speed. In addition, differs from “fan indicator”, this option is used for controlling the fans.

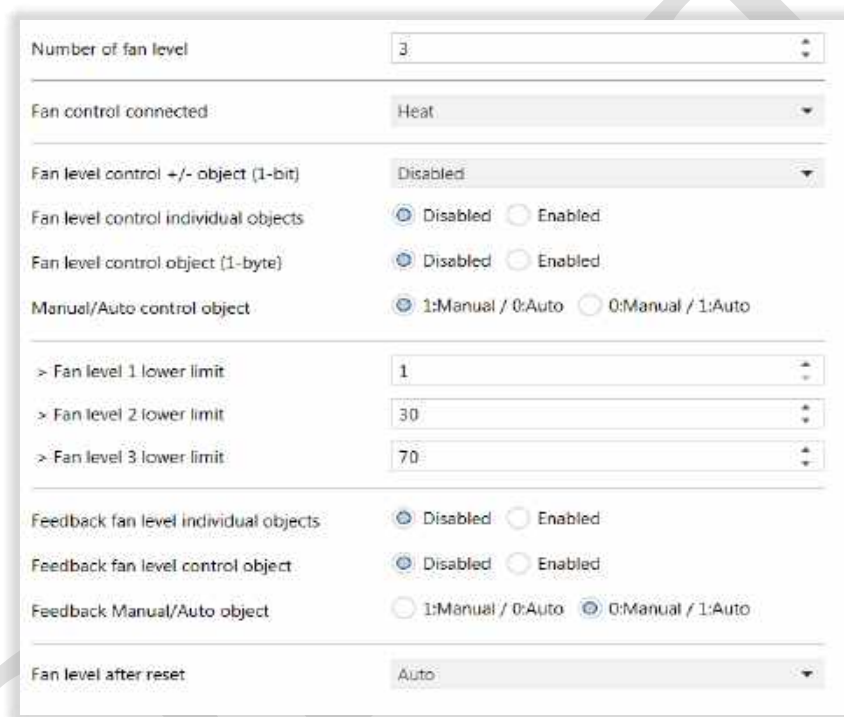

Fig 35 : Fan Control Configuration Used For Room Controller

5.4.7.5. Parameters List

PARAMETER	DESCRIPTION	VALUES
Number of fan level	The number of fan level is determined with this parameter.	3 (1...5)
Fan control connected	This parameter allows the fan controls to work together with the “heating”, “cooling” or “heating / cooling” system.	Heat Cool Heat & Cool

Fan level control + / – object (1 – bit)	This parameter allows the control of the fan speed with 1 – bit object.	Disabled 1 : Increase / 0 : Decrease 1 : Down / 0 : Up
Fan level control individual objects	This parameter allows the control of the fan speed with 1 – bit individual objects.	Disabled Enabled
Fan level control object (1– byte)	This parameter allows the control of the fan speed with 1 – byte object.	Disabled Enabled
Manual / Auto control object	Manual or automatic fan speed control is selected with this parameter.	1 : Manual / 0 : Auto 0 : Manual / 1 : Auto
Fan level 1 lower limit	The lower limit value of the 1st speed is determined with this parameter.	1 (1...100)
Fan level 2 lower limit	The lower limit value of the 2nd speed is determined with this parameter.	30 (1...100)
Fan level 3 lower limit	The lower limit value of the 3rd speed is determined with this parameter.	70 (1...100)
Feedback fan level individual objects	Fan speed feedback is received with individual objects by this parameter.	Disabled Enabled
Feedback fan level control object	Fan speed feedback is received with 1 byte object by this parameter.	Disabled Enabled
Feedback Manual / Auto Object	Manual or automatic fan speed feedback is received with this parameter.	1 : Manual / 0 : Auto 0 : Manual / 1 : Auto
Fan level after reset	The desired fan level after a power failure is determined with this object.	Previous value Off Level 1 Level 2 Level 3 Auto

5.4.7.6. Objects List

Object Name	Function	Type	Flags
Fan Controller +/-	1 : Increase / 0 : Decrease 1 : Down / 0 : Up	1 bit	CRWTU
This object is used to increase or decrease the fan speed.			
Fan Controller 1 – byte	0 – OFF; 1 – Speed 1; 2 – Speed 2; 3 – Speed 3; 4 – Speed 4; 5 – Speed 5	1 byte	CRWTU
This object allows the fan speed to be controlled with 1 byte data.			
Fan Controller Individual Level 1	1 – On / 0 – Off	1 bit	CRWTU
This object is used to switch over to 1st fan level.			
Fan Controller Individual Level 2	1 – On / 0 – Off	1 bit	CRWTU
This object is used to switch over to 2nd fan level.			
Fan Controller Individual Level 3	1 – On / 0 – Off	1 bit	CRWTU
This object is used to switch over to 3rd fan level.			
Fan Controller Individual Level 4	1 – On / 0 – Off	1 bit	CRWTU
This object is used to switch over to 4th fan level.			
Fan Controller Individual Level 5	1 – On / 0 – Off	1 bit	CRWTU
This object is used to switch over to 5th fan level.			
Fan Controller Manual / Auto	1 – On / 0 – Off	1 bit	CRWTU

This object is used to switch over to automatic or manual fan speed control mode.

Fan Controller 1 – byte Feedback	0 – OFF; 1 – Speed 1; 2 – Speed 2; 3 – Speed 3; 4 – Speed 4; 5 – Speed 5	1 byte	CRTU
----------------------------------	--	--------	------

This object indicates the fan speed status with 1 byte value.

Fan Controller Individual Level 1 Feedback	1 – On / 0 – Off	1 bit	CRTU
--	------------------	-------	------

This object indicates the 1st fan speed status with 1 bit value.

Fan Controller Individual Level 2 Feedback	1 – On / 0 – Off	1 bit	CRTU
--	------------------	-------	------

This object indicates the 2nd fan speed status with 1 bit value.

Fan Controller Individual Level 3 Feedback	1 – On / 0 – Off	1 bit	CRTU
--	------------------	-------	------

This object indicates the 3rd fan speed status with 1 bit value.

Fan Controller Individual Level 4 Feedback	1 – On / 0 – Off	1 bit	CRTU
--	------------------	-------	------

This object indicates the 4th fan speed status with 1 bit value.

Fan Controller Individual Level 5 Feedback	1 – On / 0 – Off	1 bit	CRTU
--	------------------	-------	------











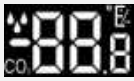



This object indicates the 5th fan speed status with 1 bit value.

Fan Controller Manual / Auto Feedback	1 – On / 0 – Off	1 bit	CRTU
---------------------------------------	------------------	-------	------

This object indicates the manual / automatic fan operating mode with 1 bit value.

5.5. LCD PAGE

There is an LCD display located at the middle of the device, vertically positioned, 40 x 90 mm (G x Y) sized and configurable backlight intensity. The configuration settings made with the ETS software and the symbols of the following controls can be displayed on the screen.

Symbol	Meaning	Symbol	Meaning
	Temperature(°C or °F), relative humidity (percentage %) and CO2 concentration.		Heating (When the symbol is steady, it indicates that the device is in heating mode. If the heating system is active the heating symbol flashes.)
	Fan control (Automatic fan mode option and up to 5 fan levels control option.)		Cooling (When the symbol is steady, it indicates that the device is in cooling mode. If the cooling system is active the cooling symbol flashes.)
	Internal temperature information		Night mode
	External temperature information		Protection mode
	Thermostat ON / OFF		Comfort mode
	Alarm indicator		Standby mode
	Locking function		Setpoint temperature

5.5.1. General

This parameter can be used to adjust the brightness level of the display, to show the actual temperature, the outside temperature, the relative humidity, the air quality level, to configure switching time between them, to show whether the horizontal lines will be appeared on the display, to control the display on / off status information.

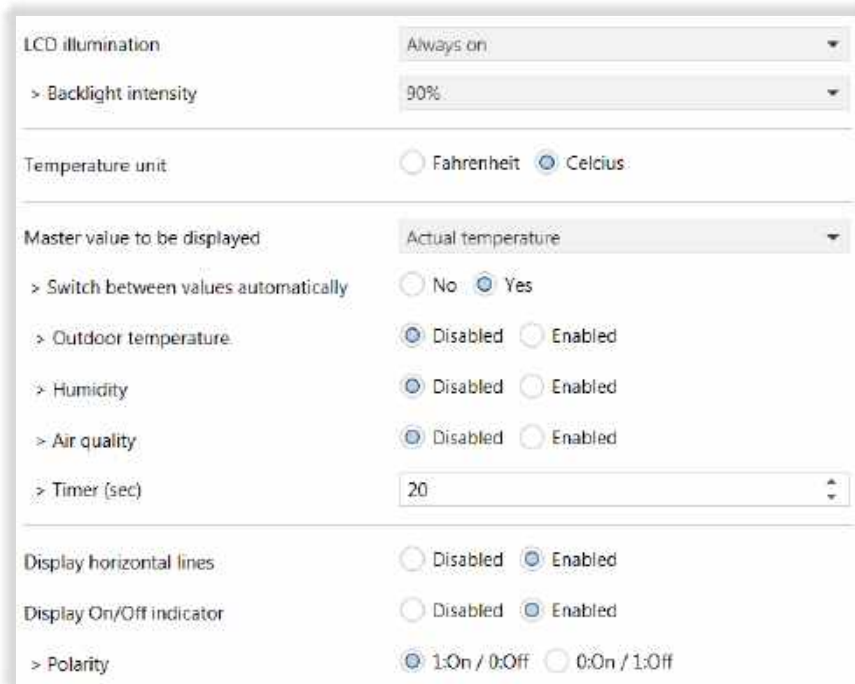

Fig 36 : LCD General Configuration Section

5.5.1.1. Parameters List

PARAMETER	DESCRIPTION	VALUES
LCD illumination	The illumination of the display is controlled with this parameter. Always off : LCD illumination is always off. Always on : LCD illumination is always on. Auto switch down : The display is turned off or switches to a new illumination level after the set time(1...255 sec) elapsed.	Always off Always on Auto switch down
Backlight intensity	The backlight intensity of the LCD display is configured with this parameter.	90% (10%...100%)
Timer (sec)^{*1}	The illumination time of the LCD display is configured with this parameter.	60 (0...255)
Intensity after timer^{*1}	The illumination intensity of the LCD screen is determined after the time defined by this parameter is over.	30% (10%...100%)

Temperature unit	The temperature unit type to be displayed is defined by this parameter.	Fahrenheit Celcius
Master value to be displayed	Master value to be displayed on the screen is selected with this parameter.	Actual temperature Setpoint temperature Outdoor temperature Humidity Sensor Air quality
Switch between values automatically	it is determined with this parameter whether the set point temperature, air quality, humidity, outdoor temperature information will appear in the main display, and then switch between them automatically.	No Yes
Setpoint temperature²	Whether the setpoint temperature is displayed on the LCD screen is determined with this parameter.	Disabled Enabled
Outdoor temperature²	Whether the outdoor temperature is displayed on the LCD screen is determined with this parameter.	Disabled Enabled
Air quality²	Whether the air quality is displayed on the LCD screen is determined with this parameter.	Disabled Enabled
Timer (sec)²	Bu parametre ile ana ekrandaki deęer ve dięer deęerlerin otomatik olarak geiř zamanı belirlenir.	20 (0...255)
Display horizontal lines	Whether the horizontal separating lines is displayed on the LCD screen is determined with this parameter.	Disabled Enabled
Display On / Off indicator	Whether the On / Off indicator is displayed on the LCD screen is determined with this parameter.	Disabled Enabled
Polarity³	On / Off indicator's operation mode is determined with this parameter.	1 : On / 0 : Off 0 : On / 1 : Off
Display Heat / Cool requirement indicator	It is determined, whether the indicator on whether the heating / cooling system is operating will be shown on the display, with this parameter	Disabled Enabled

¹This parameter is only visible, when the parameter “LCD illumination” is set to “Auto switch down”.

²This parameter is only visible, when the parameter “Switch between values automatically” is set to “Yes”.

³This parameter is only visible, when the parameter “Display On / Off indicator” is set to “Enabled”.

5.5.1.2. Objects List

Object Name	Function	Type	Flags
LCD Backlight Intensity	0% – 100%	1 Byte	CRWTU
This object is used to configure the LCD's backlight intensity.			
LCD On / Off indicator	On / Off	1 Bit	CRWTU
This object is used to control the “On” and “Off” indicators that are displayed on the LCD screen.			
External Air Quality	0 (ppm) – 670760 (ppm)	2 byte	CRWTU
This object is used to display external air quality value on the LCD screen.			
External Outdoor Temp.	0 (°C) – 670760 (°C)	2 byte	CRWTU

This object is used to display external outdoor temperature value on the LCD screen.

5.5.2. Buttons

There are 2 buttons on the LCD screen. These buttons are located at above and below of the middle part. The general purpose of the buttons is designed to change the setpoint temperature. It is possible to select the different controls required by the button settings in the parameters section and to lock the buttons through of an object and to define different controls as short press, long press.

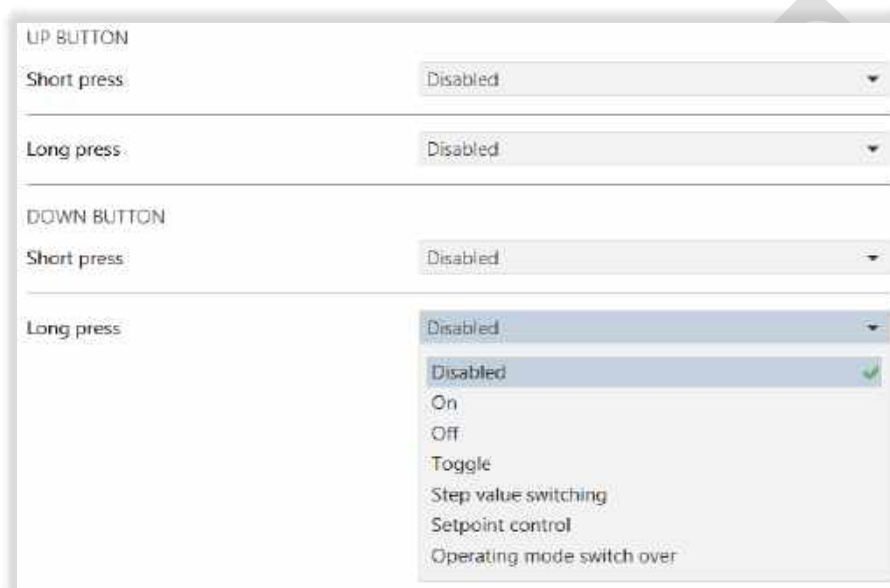

Fig 37 : LCD Button Configuration

5.5.2.1. Parameters List

PARAMETER	DESCRIPTION	VALUES
Short press	This parameter determines the type of data to be sent when a short press action occurs.	Disabled On Off Toggle Step value switching Setpoint control Operating mode switch – over

Locking	<p>This parameter determines whether the push button lock is enabled with an additional locking object. When this function used, the locked push button does not send any data to the bus line.</p> <p>Disabled : With this option, device lock is disabled permanently.</p> <p>Lock on value 0 : When a logic 0 value is send to push button locking object, the push button will be locked.</p> <p>Lock on value 1 : When a logic 1 value is send to push button locking object, the push button will be locked.</p>	<p>Disabled</p> <p>Lock on value 0</p> <p>Lock on value 1</p>
Sending delay	<p>When an event occurs, this parameter allows to configure telegram sending time to bus line. Values are entered in seconds. Entering the “0” value means which the telegram is sent to bus line without delay.</p>	<p>0 (0...255)</p>
Sending periodically	<p>This parameter is used to periodically send the commands to bus line.</p>	<p>Disabled</p> <p>Enabled</p>
Period of sending (sec)	<p>This parameter determines sending periods of the commands to bus line.</p>	<p>0 (0...255)</p>
Modification by pressing	<p>This parameter is used to switch between operating modes.</p>	<p>Comfort mode</p> <p>Standby mode</p> <p>Night mode</p> <p>Building protection mode</p> <p>Comfort & Standby</p> <p>Comfort & Night</p> <p>Comfort & Standby & Night</p> <p>All</p>

Long press	This parameter determines the type of data to be sent when a long press action occurs.	Disabled On Off Toggle Step value switching Setpoint control Operating mode Switch – over
Locking	This parameter determines whether the push button lock is enabled with an additional locking object. When this function used, the locked push button does not send any data to the bus line. Disabled : With this option, device lock is disabled permanently. Lock on value 0 : When a logic 0 value is send to push button locking object, the push button will be locked. Lock on value 1 : When a logic 1 value is send to push button locking object, the push button will be locked.	Disabled Lock on value 0 Lock on value 1
Sending delay	When an event occurs, this parameter allows to configure telegram sending time to bus line. Values are entered in seconds. Entering the “0” value means which the telegram is sent to bus line without delay.	0 (0...255)
Sending periodically	This parameter is used to periodically send the commands to bus line.	Disabled Enabled
Period of sending (sec)	This parameter determines sending periods of the commands to bus line.	0 (0...255)

5.5.2.2. Objects List

Obje Adı	Fonksiyonu	Tipi	Bayrakları
LCD Up/Down Button Short/Long – On	ON / OFF	1 bit	CRTU
“ON” telegram will be sent via this object connected to related group address.			
LCD Up/Down Button Short/Long – Off	ON / OFF	1 bit	CRTU
“OFF” telegram will be sent via this object connected to related group address.			
LCD Up/Down Button Short/Long – Toggle	ON / OFF	1 bit	CRTU
“Toggle” telegram will be sent via this object connected to related group address.			
LCD Up/Down Button Short/Long – Feedback Toggle	Status	1 bit	CRWU
This object appears only when the toggle function is enabled. Output status is shown via this object connected to related group address.			
LCD Up/Down Button Short/Long – Step 1 Byte	1 byte unsigned value / Percentage	1 byte	CRTU
The 1 byte value sent by this object can be in the range (0 – 255). Values will be sent via this object connected to related group address.			
LCD Up/Down Button Short/Long – Step 2 Byte	2 byte unsigned value	2 byte	CRTU
The 2 byte value sent by this object can be in the range (0 – 65535). Values will be sent via this object connected to related group address.			
LCD Up/Down Button Short/Long – Step Percentage	Percentage (%)	1 byte	CRTU
The percentage value sent by this object can be in the range (0 – 100). Values will be sent via this object connected to related group address.			
LCD Up/Down Button Short/Long – Step Temperature	Temperature (Celcius)	2 byte	CRTU
The temperature setpoint value sent by this object can be in the range (0 – 50°C). Values will be sent via this object connected to related group address.			
LCD Up/Down Button Short/Long – Step Luminosity	Luminosity (Lux)	2 byte	CRTU

The luminosity value sent by this object can be in the range (0 – 1000). Values will be sent via this object connected to related group address.

LCD Up/Down Button Short/Long – Step Scene	Scene control	1 byte	CWT
--	---------------	--------	-----

The scene call value sent by this object can be in the range (0 – 64). Values will be sent via this object connected to related group address.

LCD Up/Down Button Short/Long – Locking	0 – Disable / 1 – Enable 1 – Disable / 0 – Enable	1 bit	CWT
---	--	-------	-----

This object appears only when the locking function is enabled. Via the related group address, it is possible to lock the push button by configuration is done before.

LCD Up/Down Button Short/Long – Operating Mode	HVAC	1 byte	CRTU
--	------	--------	------

Switching between the operating modes is possible via this object connected to related group address.

LCD Up/Down Button Short/Long – Setpoint Temperature	Temperature (°C)	2 bytes	CRTU
--	------------------	---------	------

The selected setpoint temperature for push button is controlled via this object connected to related group address.

LCD Up/Down Button Short/Long – Feedback Setpoint Temperature	Temperature (°C)	2 bytes	CRTWU
---	------------------	---------	-------

The status of selected setpoint temperature for push button is received via this object connected to related group address.

5.6. HUMIDITY SENSOR

The integrated humidity sensor on the device provides the measurement of the relative humidity value in the ambience. The measured value allows you to perform an upgraded room thermoregulation and to expand combinations for the safe operation of some type of terminal equipment used for cooling. The measured value can also be sent to the KNX bus line via 2-byte communication object. The psychrometric values obtained from the temperature and humidity combination measurement such as dew – point temperature on the KNX bus line and the perceived temperature index (in summer mode only) can also be sent, with the calculation made by the thermostat.

Humidity sensor Internal External

> Internal sensor calibration 0%

> Minimum oscillation of humidity to send 2%

> Sending of actual humidity periodically Disabled Enabled

Threshold 1 Disabled

Threshold 2 Disabled

Fig 38 : Humidity Sensor Configuration Page

5.6.1. Parameters List

PARAMETER	DESCRIPTION	VALUES
Humidity sensor	This parameter determines whether the humidity sensor is external or internal.	Internal External
Internal sensor calibration	This parameter determines the percentage of internal sensor calibration.	0% (-10%...10%)
Minimum oscillation of humidity to send (%)	This parameter determines the minimum oscillation value for the output object to send the humidity value.	Disabled, 1%, 2% , 3%, 4%, 5%, 6%, 7%, 8%, 9%, 10%
Sending of actual humidity periodically	This parameter allows the periodically measured humidity to be sent. The periodic transmission time can be selected between the range of 1 to 255.	Disabled Enabled
Threshold 1	First threshold value property is activated by this parameter.	Disabled High Low
Higher limit (%)	Higher limit of first threshold is determined by this parameter.	90 (0...100)
Lower limit (%)	Lower limit of first threshold is determined by this parameter.	30 (0...100)
Threshold 2	Second internal threshold value property is activated by this parameter.	Disabled High Low

Higher limit (%)	Higher limit of second threshold is determined by this parameter.	90 (0...100)
Lower limit (%)	Lower limit of second threshold is determined by this parameter.	30 (0...100)

5.6.2. Objects List

Object Name	Function	Type	Flags
Actual Relative Humidity	Humidity (%)	2 byte	CRTU
The actual relative humidity is received with this object via connected to related group address.			
External Relative Humidity	Humidity (%)	2 byte	CRWTU
The external relative humidity is received with this object via connected to related group address.			
Humidity Threshold 1	1 – True / 0 – False	1 bit	CRTU
First threshold value property for relative humidity is configured by this object.			
Humidity Threshold 2	1 – True / 0 – False	1 bit	CRTU

Second threshold value property for relative humidity is configured by this object.

CONTACT INFORMATION

THE INTERRA WEB SITE

Interra provides documentation support via our WWW site www.interra.com.tr. This web site is used as a means to make files and information easily available to customers. Accessible by using your favorite Internet browser, the web site contains the following information:

- Information about our products and projects.
- Overview of Interra company and values.
- Product Support: Data sheets, product manuals, application descriptions, latest software releases, ETS databases and archived softwares.

EUROPE, Turkey

Interra

Cumhuriyet mah. Kartal cad. Simkan Plaza No:95/1

Kartal/İstanbul

Tel: +90 (216) 326 26 40 Fax: +90 (216) 324 25 03

Web adress: <http://www.interra.com.tr/>

DRAFT